

CATALOGO

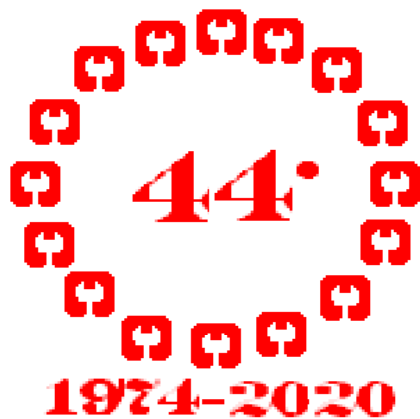

CONDIZIONI GENERALI DI VENDITA

La merce viaggia sempre a rischio e pericolo del committente, anche se resa in porto franco.

L'imballo è a carico dell'acquirente, fatturato una tantum non accettato di ritorno.

Qualsiasi reclamo deve essere effettuato entro OTTO giorni dal ricevimento della merce a mezzo lettera raccomandata.

Eventuali contestazioni non danno diritto all'acquirente di differire i pagamenti.

I pagamenti sono validi unicamente se effettuati alla nostra Amministrazione. Sui i ritardi dei pagamenti si applicheranno gli interessi di mora al tasso commerciale in uso.

I nostri prodotti non sono originali ma perfettamente intercambiabili.

Ci si riserva ogni diritto di apportare modifiche e aggiornamenti del presente catalogo senza preavviso.

I codici, le misure e i disegni sono indicativi, senza impegno da parte del venditore. E' vietato la riproduzione, anche parziale del presente catalogo.

I campioni ricevuti non si restituiscono.

La garanzia è valida solo per i prodotti che si accerti un difetto di fabbricazione e non per cause di trasporto o di errata manipolazione. I resi dovranno esserci inviati in porto franco senza richiesta di rimborso delle spese.

Il foro di Milano è unico competente per qualsiasi controversia.



MOTORICAMBIO SAS

di Fiori E. & C.

Via Manenti 2 - Sede Via Roma 140

Tel 0382-1471834 - 27018 Vidigulfo (Pv)

E-Mail: motoricambio@virgilio.it - www.motoricambio.it





LEGENDA – INDICE

ARTICOLO AA BB CCC (Esempio 01 01 101)

AA	PAG	AA	PAG	AA	PAG
01 - FILI INTERNI	2	08 - TRASMISSIONI CONTAGIR	20	15 - VALVOLE - LAMELLE	25
02 - TRASMISSIONI COMPLETE	3	09 - FLESSIBILI CONTAKM	19	16 - FILTRI ARIA	26
03 - GUAINA	11	10 - TR FRENO ANTERIORE	20	17 - RICAMBI PIAGGIO	27
04 - TUBI PLASTICI	14	11 - TR FRENO POSTERIORE	21	18 - RICAMBI CAVIGA 75cc	30
05 - MINUTERIA METALLICA	12	12 - TR ACCELERATORE	22	19 - RICAMBI FANTIC 75cc	31
06 - MATASSE CORDINA	14	13 - TR DECOMPRESSORE	14	20 - FASCETTE NYLON	25
07 - TRASMISSIONI CONTAKM	15	14 - TR FRIZIONE	24		

AA	PAG	BB	PAG	BB	PAG
01 - FILI INTERNI	2	01 - FRIZIONE	2	04 - FRENO CICLO	10
02 - TRASMISSIONI COMPLETE	3	02 - CAMBIO	4	05 - AVVIAMENTO APE 50	8
		03 - ACCELERATORE	5	05 - STARTER	8
		04 - FRENO MOTO - PIAGGIO	7	06 - RETROMARCIA APE	9
		04 - FRENO A MANO APE	8	07 - KIT TRAMMISSIONI	11

AA	PAG	BB	PAG
03 - GUAINA	11	01 - ECONOMICA	11
		02 - TRAFILATA	11
		03 - TUBETTO NYLON	11

AA	PAG	BB	PAG
04 - TUBI PLASTICI	14	01 - PVC - ATOSSICO	14
		02 - ARI	14
		03 - ALTA PRESSIONE	14





AA	PAG	BB	PAG
06 - MATASSE CORDINA	14	01 - ACCIAIO 19 CAPI	14
		02 - TREFOLO 49 CAPI	14

AA	PAG	BB	PAG	BB	PAG
17 - RICAMBI	27	01 - CAVALLETTI	27	06 - PRESELETTORI CAMBIO	28
		02 - COLLETTORI	27	07 - TAMBURI FRENO ANT	28
		03 - LEVE FRENO - FRIZIONE	27	07 - TAMBURI FRENO POST	29
		04 - PEDIVELLE M/M	28	09 -	
		05 - PERNI MOLEGGIO	28	10 - VARI	29

BB	BB	BB
01 - APRILIA	19 - GARELLI	39 - MALANCA
02 - ASPES	20 - MOTO GILERA	41 - M B K - YAMAHA
03 - ATALA	24 - HIRO	46 - MOTO GUZZI
04 - BENELLI	25 - HONDA	47 - MOTO MORINI
05 - BETA	26 - HUSQVARNA	48 - MOTO TM
06 - CARBURATORI BING	27 - KAWASAKI	50 - OSSA
08 - BULTACO	28 - KIMCO	54 - PEUGEOT
09 - CAGIVA	29 - K T M	55 - P.G.O.
12 - IMPIANTI CEV	30 - ITALJET	56 - PIAGGIO - GILERA
15 - DUCATI	34 - INNOCENTI LAMBRETTA	58 - ROTAX
16 - FANTIC MOTOR	35 - LAVERDA	60 - SACHS
17 - FBM - MINARELLI	37 - MAICO	61 - SUZUKI
18 - FRANCO MORINI	38 - MALAGUTI	64 - YAMAHA MOTO

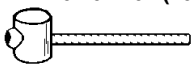
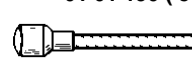
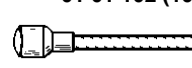
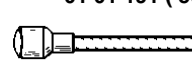
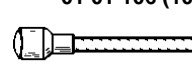
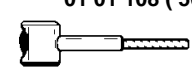

COMANDI FLESSIBILI FRIZIONE

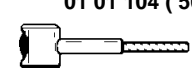
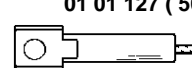
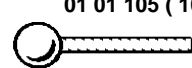
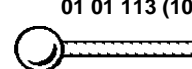
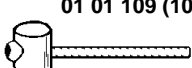
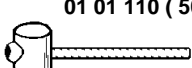
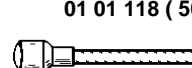
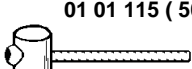
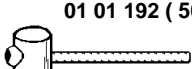
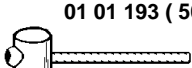
ARTICOLO	DESCRIZIONE
 01 01 101 (100)	FILO FRIZIONE VESPA
 01 01 107 (100)	FILO FRIZIONE VESPA TESTA SFILABILE
 01 01 190 (50)	FILO FRIZIONE VESPA - MOTO SVEDEN
 01 01 102 (100)	FILO FRIZIONE VESPA 50/125 PK
 01 01 191 (50)	FILO FRIZIONE VESPA - MOTO SVEDEN
 01 01 106 (100)	FILO FRIZIONE APE 50
 01 01 108 (50)	FILO FRIZIONE APE 50 SVEDEN
 01 01 103 (50)	FILO FRIZIONE APE MP
 01 01 104 (50)	FILO FRIZIONE APE MP VOLANTE
 01 01 127 (50)	FILO FRIZIONE APE TM 703
 01 01 105 (10)	FILO FRIZIONE APE CAR - POKER
 01 01 113 (100)	FILO FRIZIONE MOTO
 01 01 109 (100)	FILO FRIZIONE MOTOCARRI
 01 01 110 (50)	FILO FRIZIONE MOTO CROSS
 01 01 118 (50)	FILO FRIZIONE/FRENO MOTOCOLTIVATORE
 01 01 115 (50)	FILO FRIZIONE MOTOCOLTIVATORE
 01 01 192 (50)	FILO FRIZIONE MOTOCOLTIVATORE SFILABILE
 01 01 193 (50)	FILO FRIZIONE MOTOCOLTIVATORE SFILABILE
 01 01 129 (50)	FILO FRIZIONE MOTOCOLTIVATORE SFILABILE

SIMILE	TESTA	CAVO	GUAINA
		D - cm	D - cm
	8 x 8	1,9 x 200	
	8 x 8 SFERA	1,9 x 200	
	8 x 8 SFERA	SVEDEN 1,9 x 200	
	a T	1,9 x 200	
	a T	SVEDEN 1,9 x 200	
	a T	1,9 x 320	
	A T	SVEDEN 1,9 x 320	
	9 x 8 ORIGINALE	1,9 x 290	
	GANCIO	1,9 x 200	
	7 x 8 ORIGINALE	1,9 x 350	
	OCCHIELLO	2,5 x 420	
	SFERA	1,9 x 200	
	SFERA	1,9 x 300	
	9 x 9 SFERA	2,5 x 155	
	9 x 9 SFERA	2,5 x 250	
	a T	2,5 x 250	
	9 X 9 SFERA	SVEDEN 2,5 x 250	
	9 x 9 SFERA	SVEDEN 2,5 x 300	
	10 x 12 SFERA	3,0 x 250	



COMANDI FLESSIBILI COMPLETI FRIZIONE

ARTICOLO	DESCRIZIONE
02 01 201	TRASMISSIONE FRIZIONE VESPA (GRIGIO-NERO)
02 01 202	TRASMISSIONE FRIZIONE VESPA (GRIGIO-NERO)
02 01 207	TRASMISSIONE FRIZIONE VESPA (GRIGIO-NERO)
02 01 290	TRASMISSIONE FRIZIONE MOTO SVEDEN (NERO)
02 01 206	TRASMISSIONE FRIZIONE APE 50
02 01 203	TRASMISSIONE FRIZIONE APE MP
02 01 205	TRASMISSIONE FRIZIONE APE CAR
14 56 340	TRASMISSIONE FRIZIONE APE MP 601
14 56 340V	TRASMISSIONE FRIZIONE APE MP 601 VOLANTE
14 56 328	TRASMISSIONE FRIZIONE APE CAR MISCELATORE
14 56 356	TRASMISSIONE FRIZIONE APE CAR P2
14 56 024	TRASMISSIONE FRIZIONE APE TM 703 DIESEL
14 56 415	TRASMISSIONE FRIZIONE APE TM 703 MANUBRIO
14 56 436	TRASMISSIONE FRIZIONE APE POKER (B/D)
02 01 213	TRASMISSIONE FRIZIONE MOTO (NERO)
02 01 210	TRASMISSIONE FRIZIONE MOTO CROSS NERA
02 01 218	TRASMISSIONE FRIZIONE MOTOCOLTIVATORE

SIMILE	TESTA	CAVO	GUAINA
		D - cm	D - cm
	8 x 8	1,9 x 200	4,5 x 180
	a T	1,9 x 200	4,5 x 180
	8 x 8 SFERA	1,9 x 200	4,5 x 180
	8 x 8 SFERA	SVEDEN 1,9 x 200	TEFLON 5,0 x 180
	a T	1,9 x 320	4,5 x 300
	9 x 8 ORIGINALE	1,9 x 290	5,0 x 270
136506	OCCHIELLO	1,9 x 200	5 x 180
185312			
185314			
144530			
134105			
228700			
177150			
266494			
	SFERA	1,9 x 200	4,5 x 170
	9 x 9 SFERA	2,5 x 155	6,0 x 140
	9 x 9 SFERA	2,5 x 250	6,0 x 230



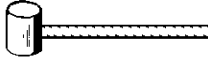
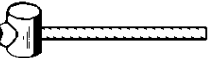
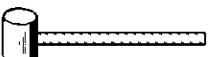
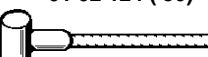
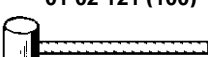
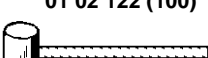
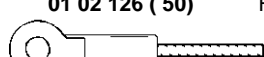

COMANDI FLESSIBILI CAMBIO



ARTICOLO	DESCRIZIONE
 01 02 120 (100)	FILO CAMBIO VESPA
 01 02 123 (100)	FILO CAMBIO VESPA SFILABILE
 01 02 124 (50)	FILO CAMBIO VESPA SVEDEN
 01 02 121 (100)	FILO CAMBIO APE MP
 01 02 122 (100)	FILO CAMBIO APE 50
 01 02 126 (50)	FILO CAMBIO APE 50 SVEDEN
 01 02 125 (5)	FILO CAMBIO APE TM - VESPA FL (RIGIDO)

SIMILE	TESTA	CAVO	GUAINA
		D - cm	D - cm
	6,5 x 5,5	1,6 x 200	
	6,5 x 5,5 SFERA	1,6 x 200	
	6,5 x 5,5	SVEDEN 1,6 x 200	
	8 x 5,5 ORIGINALE	1,6 x 260	
	6,5 x 5,5	1,6 x 330	
	6,5 x 5,5	SVEDEN 1,6 x 330	
	OCCHIELLO	1,9 x 275	



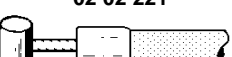
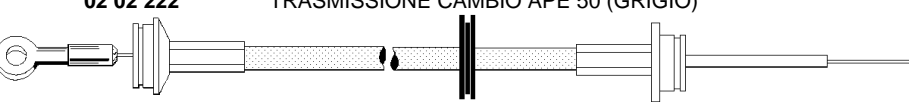
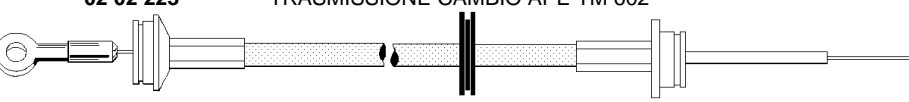







COMANDI FLESSIBILI COMPLETO CAMBIO

ARTICOLO	DESCRIZIONE
 02 02 220	TRASMISSIONE CAMBIO VESPA (GRIGIO)
 02 02 221	TRASMISSIONE CAMBIO APE MP (GRIGIO)
 02 02 222	TRASMISSIONE CAMBIO APE 50 (GRIGIO)
 02 02 223	TRASMISSIONE CAMBIO APE TM 602
 02 02 224	TRASMISSIONE CAMBIO APE TM 703

SIMILE	TESTA	CAVO	GUAINA
		D - mm	D - mm
	6,5 x 5,5	1,6 x 200	4,5 x 180
	8 x 5,5 ORIGINALE	1,6 x 260	5,0 x 240
	6,5 x 5,5	1,6 x 330	4,5 x 320
			
177596			
			
197097			

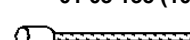
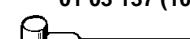
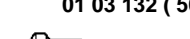
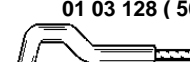
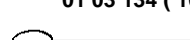
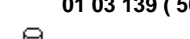

COMANDI FLESSIBILI ACCELERATORE

ARTICOLO	DESCRIZIONE
 01 03 130 (100)	FILO GAS VESPA
 01 03 196 (50)	FILO GAS VESPA - MOTO SVEDEN
 01 03 197 (50)	FILO GAS SKIPPER - HEXAGON SVEDEN
 01 03 199 (50)	FILO GAS SCOOTER SVEDEN
 01 03 131 (100)	FILO GAS VESPA
 01 03 195 (50)	FILO GAS VESPA - MOTO SVEDEN
 01 03 133 (100)	FILO GAS APE MP - POKER
 01 03 136 (50)	FILO GAS APE MP - POKER SVEDEN
 01 03 135 (100)	FILO GAS APE 50
 01 03 137 (100)	FILO GAS CICLOMOTORE
 01 03 132 (50)	FILO GAS APE MP
 01 03 128 (50)	FILO GAS APE CAR / MISCELATORE
 01 03 134 (10)	FILO GAS APE MP VOLANTE
 01 03 139 (50)	FILO GAS AGRICOLO
 01 03 198 (50)	FILO GAS BOOSTER SVEDEN

SIMILE	TESTA	CAVO	GUAINA
		D - cm	D - cm
	5,5 x 6	1,2 x 200	
	5,5 x 6	SVEDEN 1,25 x 200	
	5,5 x 6	SVEDEN 1,25 x 240	
	5,5 x 6	SVEDEN 1,25 x 3,15	
	3 x 3	1,2 x 200	
	3 x 3	SVEDEN 1,25 x 200	
	3 x 3	1,2 x 315	
	3 x 3	SVEDEN 1,25 x 315	
	3 x 2,5	1,2 x 280	
	3 x 2,5	1,2 x 145	
	8 x 5,5 ORIGINALE	1,2 x 315	
	a T	1,2 x 315	
	GANCIO	1,2 x 315	
	PASTIGLIA	1,2 x 250	
	3 x 5	SVEDEN 1,25 x 240	









COMANDI FLESSIBILI COMPLETO ACCELERATORE

ARTICOLO	DESCRIZIONE
02 03 230	TRASMISSIONE GAS VESPA (GRIGIO)
02 03 231	TRASMISSIONE GAS VESPA (GRIGIO)
02 03 295	TRASMISSIONE GAS MOTO (NERO) SVEDEN
02 03 235	TRASMISSIONE GAS APE 50 (GRIGIO)
02 03 237	TRASMISSIONE GAS CIAO - CICLMOTORE (NERO - GRIGIO)
02 03 238	TRASMISSIONE GAS CIAO - CICLMOTORE (NERO) SVEDEN
02 03 232	TRASMISSIONE GAS APE MP (GRIGIO)
02 03 234	TRASMISSIONE GAS APE MP VOLANTE (GRIGIO)
12 56 310	TRASMISSIONE COMANDO-MISCELATORE APE MP 601
12 56 308	TRASMISSIONE ACCELERATORE APE CAR
12 56 305	TRASMISSIONE COMANDO-MISCELATORE APE CAR L/S
12 56 311	TRASMISSIONE COMANDO-MISCELATORE APE TM 703 M
12 56 312	TRASMISSIONE COMANDO-MISCELATORE APE TM 703 V (Tutti)
12 56 306	TRASMISSIONE MISCELATORE-CARBURATORE MP-CAR-TM
12 56 023	TRASMISSIONE ACCELERATORE APE TM DIESEL
12 56 437	TRASMISSIONE ACCELERATORE POKER (BENZINA)
12 56 438	TRASMISSIONE ACCELERATORE POKER (DIESEL)
12 56 314	SERIE TRASMISSIONI GAS APE 50 TM

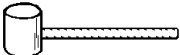
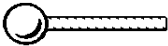
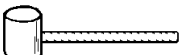
SIMILE	TESTA	CAVO	GUAINA
		D - cm	D - cm
	6 x 5,5	1,2 x 200	4,5 x 180
	3 x 3	1,2 x 200	4,5 x 180
	3 x 3	SVEDEN 1,25 x 200	TEFLON 5,0 x 180
	3 x 3	1,2 x 315	5,0 x 290
	3 x 2,5	1,2 x 145	4,5 x 120
	3 x 2,5	SVEDEN 1,25 x 145	TEFLON 5,0 x 120
	8 x 5,5 ORIGINALE	1,2 x 315	5,0 x 290
	GANCIO	1,2 x 315	5,0 x 290
160656			
137771			
13440			
177128			
611643			
248358			
225010			
224979			
228706			
266495			
260627			
567102			
567103			
567104			





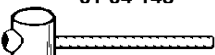

COMANDI FLESSIBILI FRENO

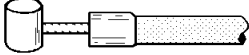

ARTICOLO	DESCRIZIONE
 01 04 140	FILO FRENO ANTERIORE VESPA ET3 - PX
 01 01 113	FILO FRENO POSTERIORE CICLOMOTORE - SAVOIRDA
 01 04 189	FILO FRENO POSTERIORE PEUGEOT 103/104
 01 04 142	FILO FRENO POSTERIORE VESPA ET3 - GT - GL
 01 04 145	FILO FRENO A MANO APE C3/C4
 01 04 147	FILO FRENO POSTERIORE VESPA PX - PE
 01 04 148	FILO FRENO POSTERIORE VESPA PX - PE
 01 04 143	FILO FRENO POSTERIORE LAMBRETTA
 01 04 119	FILO FRENO POSTERIORE SCOOTER

SIMILE	TESTA	CAVO	GUAINA
		D - cm	D - cm
	8 x 8	1,9 x 140	
	SFERA	1,9 x 200	
	8 x 8	1,6 x 180	
		2,5 x 100	
		2,5 x 500	
191803	OCCHIELLO	2,5 x 100	
191803	OCCHIELLO	3,0 x 100	
		3,0 x 100	
	8 x 8 SFERA	2,5 x 210	

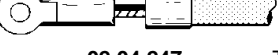
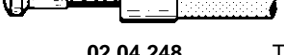
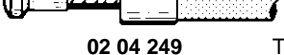
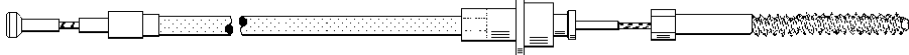

COMANDI FLESSIBILI COMPLETO FRENO







ARTICOLO	DESCRIZIONE
 02 04 240	TRASMISSIONE FRENO ANTERIORE VESPA (GRIGIO)
 02 01 213	TRASMISSIONE FRIZIONE/FRENO MOTOCICLO (NERO)
 02 04 242	TRASMISSIONE FRENO POSTERIORE VESPA 50/ET3 (GRIGIO)
 02 04 247	TRASMISSIONE FRENO POSTERIORE VESPA PX/PE (GRIGIO)
 02 04 248	TRASMISSIONE FRENO ANTERIORE CIAO-SI (GRIGIO/NERO)
 02 04 249	TRASMISSIONE FRENO POSTERIORE CIAO-SI (GRIGIO/NERO)
 10 56 470	TRASMISSIONE FRENO ANTERIORE VESPA ARCO (GRIGIO)
 11 56 368	TRASMISSIONE FRENO POSTERIORE VESPA T5 (GRIGIO)

SIMILE	TESTA	CAVO	GUAINA
		D - mm	D - mm
	8 x 8	1,9 x 140	4,5 x 120
	SFERA	1,9 x 180	4,5 x 160
		2,5 x 100	6,0 x 80
191804	OCCHIELLO	2,5 x 100	6,0 x 80
	a T	1,9 x 125	4,5 x 100
	a T	1,9 x 180	4,5 x 140
			
179642			
			
235793			



COMANDI FLESSIBILI FRENO A MANO MOTOCARRI

ARTICOLO	DESCRIZIONE
02 04 250	TRASMISSIONI FRENO A MANO APE MP 550
02 04 251	TRASMISSIONI FRENO A MANO APE MP 500 (RIDOTTO)
02 04 252	TRASMISSIONI FRENO A MANO APE MP 550 TRASMISSIONI FRENO A MANO APE MP 600 TRASMISSIONI FRENO A MANO APE MP 600 VOLANTE
02 04 253	TRASMISSIONI FRENO A MANO APE MP 500 (RIDOTTO)
02 04 254	TRASMISSIONI FRENO A MANO APE MP 550 TRASMISSIONI FRENO A MANO APE MP 600 - MP 601 TRASMISSIONI FRENO A MANO APE MP 600 VOLANTE
02 04 258	TRASMISSIONI FRENO A MANO APE TM
02 04 259	TRASMISSIONI FRENO A MANO APE TM
02 04 255	TRASMISSIONI FRENO A MANO APE CAR
02 04 256	TRASMISSIONI FRENO A MANO APE 50

SIMILE	SPECIFICHE
 117487 116573 119094	DAL TELAIO Nr.00000 AL 49501 DAL TELAIO Nr. 00000 AL 06649 DAL TELAIO Nr. 49502 AL 56567 DAL TELAIO Nr. 00000 AL 22369 DAL TELAIO Nr. 00000 AL 15202
 1740956 140247	DAL TELAIO Nr.015217 DAL TELAIO Nr.056568 DAL TELAIO Nr.022370 DAL TELAIO Nr.152203
 189752	DA LEVA A SDOPPIATORE
 214153	DA SDOPPIATORE A GANASCE
 128510	
 117675	



COMANDO AVVIAMENTO





ARTICOLO	DESCRIZIONE
01 05 159 (5)	FILO AVVIAMENTO APE 50 (RIGIDO)

SIMILE	TESTA	CAVO	GUAINA
		D - cm	D - cm
 116311	OCCHIELLO	2,5 x 172	



COMANDI FLESSIBILI RETROMARCIA









ARTICOLO	DESCRIZIONE
02 06 260	TRASMISSIONE RETROMARCIA APE MP 601
02 06 261	TRASMISSIONE RETROMARCIA APE MP 500
02 06 265	TRASMISSIONE RETROMARCIA APE TM
02 06 257	TRASMISSIONE RETROMARCIA APE TM VOLANTE
02 06 262	TRASMISSIONE RETROMARCIA APE CAR
02 06 263	TRASMISSIONE RETROMARCIA APE 50
02 06 267	TRASMISSIONE RETROMARCIA APE 50 TM

SIMILE	TESTA	CAVO D - cm	GUAINA D - cm
			
159693			
159423			
			
197069			
266596			
			
128935			
			
117309			
258646			













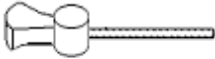

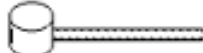

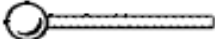
COMANDI FLESSIBILI STARTER

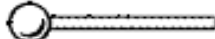
ARTICOLO	DESCRIZIONE
02 05 269	TRASMISSIONI ALZIVALVOLA CBA
02 05 270	TRASMISSIONI ALZIVALVOLA CIAO R
02 05 266	TRASMISSIONI ALZIVALVOLA BRAVO
02 05 275	TRASMISSIONI ALZIVALVOLA SI
02 05 279	TRASMISSIONI ALZIVALVOLA CIAO PX
02 05 276	TRASMISSIONI ALZIVALVOLA CIAO FL
02 05 271	TRASMISSIONE STARTER VESPA 50
02 05 272	TRASMISSIONE STARTER VESPA PRIMAVERA
02 05 273	TRASMISSIONE STARTER VESPA GT-PX/PE
02 05 268	TRASMISSIONE STARTER PX/ PE L/SEPARATA
13 56 445	TRASMISSIONE STARTER APE POKER (BENZINA-DIESEL)
13 56 264	TRASMISSIONE STARTER APE CAR
13 56 274	TRASMISSIONE STARTER MP 601
13 56 277	TRASMISSIONE STARTER APE 50
02 05 278	TRASMISSIONE STARTER LAMBRETTA LI

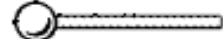
SIMILE	TESTA	CAVO D - cm	GUAINA D - cm
			
103217		1,2 x 114,5 1,2 x 90,0	4,5 x 105,5 4,5 x 84,0
			
213025		1,2 x 90,0	4,5 x 80,5
212687		1,2 x 94,0	4,5 x 84,0
267557		1,2 x 91,0 1,2 x 90,0	4,5 x 84,0 4,5 x 84,0
			
982212		1,2 x 19,5	4,5 x 14,5
1523912		1,2 x 19,5	4,5 x 13,5
			
92370		1,2 x 55,5	4,5 x 46,5
104292			
			
267299			
			
140334			
			
142538			
			
194821			
INNOCENTI			
190150150		1,2 x 45,0	4,5 x 34,5

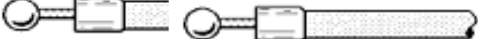
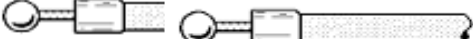
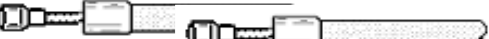

COMANDI FLESSIBILI FRENO CICLO

ARTICOLO	DESCRIZIONE
COLORI : BIANCO-NERO-GRIGIO-ROSSO-VERDE-BLUE	
 01 04 171 (50)	TIRANTE FRENO MTB
 01 02 177 (50)	CAVETTO DERAGLIATORE MTB
 01 04 172 (50)	CAVETTO FRENO POSTERIORE MTB
 02 04 280 (50)	TRASMISSIONE FRENO POSTERIORE MTB
 01 04 180 (100) 01 04 181 (100)	CAVETTO FRENO ANTERIORE CICLO CAVETTO FRENO ANTERIORE CICLO
 02 04 281 (50)	TRASMISSIONE FRENO ANTERIORE CICLO
 01 04 182 (100) 01 04 183 (100)	CAVETTO FRENO ANTERIORE SAVOIARDA CAVETTO FRENO ANTERIORE SAVOIARDA
 02 04 282 (50)	TRASMISSIONE FRENO ANTERIORE SAVOIARDA
 01 04 186 (100) 01 01 113 (100)	CAVETTO FRENO POSTERIORE SAVOIARDA CAVETTO FRENO-FRIZIONE SAVOIARDA-MOTO
 02 04 286 (50)	TRASMISSIONE FRENO POSTERIORE SAVOIARDA
 01 04 187 (100)	CAVETTO FRENO ANTERIORE CICLO CORSA
 02 04 287 (50)	TRASMISSIONE FRENO ANTERIORE CICLO CORSA
 01 04 188 (100)	CAVETTO FRENO POSTERIORE CICLO CORSA
 02 04 288 (50)	TRASMISSIONE FRENO POSTERIORE CICLO CORSA
 02 04 280	COPPIA TRASMISSIONI FRENO MTB
 02 04 285	COPPIA TRASMISSIONI FRENO CICLO
 02 04 294	COPPIA TRASMISSIONI FRENO SAVOIARDA
 02 04 289	COPPIA TRASMISSIONI FRENO CICLO CORSA

SIMILE	TESTA	CAVO	GUAINA
		D - cm	D - cm
		1,6 x 40	
	8 x 7	1,2 x 160	
	4 x 4	1,6 x 200	
	4 x 4	1,6 x 200	4,5 x 180
	SFERA	1,6 x 55	
	SFERA	1,9 x 55	
	SFERA	1,9 x 55	4,5 x 40
	SFERA	1,6 x 85	
	SFERA	1,9 x 85	
	SFERA	1,9 x 85	4,5 x 70
	SFERA	1,6 x 180	
	SFERA	1,9 x 200	
	SFERA	1,9 x 180	4,5 x 165
	a T	1,6 x 65	
	a T	1,6 x 65	4,5 x 55
	a T	1,6 x 165	
	a T	1,6 x 165	4,5 x 155



KIT TRASMISSIONI

ARTICOLO	APPLICAZIONE	
02 07 290	SERIE TRASMISSIONI CIAO R	(GRIGIO)
02 07 291	SERIE TRASMISSIONI CIAO PX	(NERO)
02 07 292	SERIE TRASMISSIONI SI	(NERO)
02 07 293	SERIE TRASMISSIONI VESPA GT-PX-PE-50-125	(GRIGIO)
02 07 295	SERIE TRASMISSIONI VESPA GT-PX-PE-50-125	(RIGATA)
02 07 294	SERIE TRASMISSIONI VESPA GT-PX-PE-50-125	(TEFLON)

COMPOSIZIONE	
(GRIGIO)	FRENO ANT-FRENO POST-ALZIVALVOLA-GAS (4)
(NERO)	FRENO ANT-FRENO POST-ALZIVALVOLA-GAS (4)
(NERO)	FRENO ANT-FRENO POST-ALZIVALVOLA-GAS (4)
(GRIGIO)	FRENO ANT-FRZIONE-2 CAMBIO-GAS (5)
(RIGATA)	FRENO ANT-FRZIONE-2 CAMBIO-GAS (5)
(TEFLON)	FRENO ANT-FRZIONE-2 CAMBIO-GAS (5)



GUAINA ECONOMICA

ARTICOLO	DESCRIZIONE
03 01 560 (50 mt)	GUAINA RIVESTITA PVC D 4,5
03 01 561 (50 mt)	GUAINA RIVESTITA PVC D 5,0
03 01 562 (50 mt)	GUAINA RIVESTITA PVC D 6,0
03 01 563 (50 mt)	GUAINA RIVESTITA PVC D 7,0
03 01 564 (50 mt)	GUAINA RIVESTITA PVC D 8,0
03 01 565 (50mt)	GUAINA RIVESTITA PVC D 9,0

COLORE	D. C/PVC	D. CAVO
B-N-G-R-V-BL-GI	5,5	2,0
NERO-GRIGIO-ROSSO	6,0	2,5
NERO-GRIGIO	7,0	3,0
NERO-GRIGIO	8,0	4,0
NERO	9,0	5,0
NERO	10,0	6,0



GUAINA TRAFILATA

ARTICOLO	DESCRIZIONE
03 02 572 (25 mt)	GUAINA RIVESTITA PVC D 4,5 CON TUBETTO
03 02 570 (25mt)	GUAINA RIVESTITA PVC D 5,0 CON TUBETTO
03 02 571 (25 mt)	GUAINA RIVESTITA PVC D 6,0 CON TUBETTO

COLORE	D. C/PVC	D. CAVO
NERO-GRIGIO-ROSSO	5,0	1,9
NERO-GRIGIO-ROSSO	5,5	2,2
NERO-GRIGIO-ROSSO	6,5	2,5















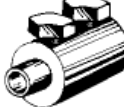





SPEZZONI GUAINA

ARTICOLO	DESCRIZIONE
03 03 045 (20)	SPEZZONE GUAINA ECONOMICA C/CAPIGUIANA D 4,5
03 03 050 (20)	SPEZZONE GUAINA ECONOMICA C/CAPIGUIANA D 5
03 03 060 (20)	SPEZZONE GUAINA ECONOMICA C/CAPIGUIANA D 6
03 04 045 (20)	SPEZZONE GUAINA TRAFILATA C/CAPIGUIANA D 4,5
03 04 050 (20)	SPEZZONE GUAINA TRAFILATA C/CAPIGUIANA D 5
03 04 060 (20)	SPEZZONE GUAINA TRAFILATA C/CAPIGUIANA D 6

COLORE	LUNGHEZZA mm
NERO-GRIGIO	180
NERO-GRIGIO	180
NERO-GRIGIO	180
NERO-GRIGIO	180
NERO-GRIGIO	180
NERO-GRIGIO	180















MINUTERIE METALLICHE

ARTICOLO	DESCRIZIONE	CONFEZIONE	INTERNO	ESTERNO	LUNGHEZZA
			mm	mm	mm
	05 01 500 MORSETTO VITE LATERALE PER CAVI FRIZIONE	100	2	7	12
	05 01 501 MORSETTO VITE LATERALE PER CAVI FRENO	100	3	8	12
	05 01 502 MORSETTO VITE LATERALE PER CAVI AGRICOLI	25	4	12	18
	05 01 539 MORSETTO VITE LATERALE PER CAVI AGRICOLI 2 FORI	25	4	12	22
	05 01 503 MORSETTO CARBURATORE SPILLO	100	1,5	4	12
	05 01 504 MORSETTO CARBURATORE SPILLO CORTO	100	1,5	4	8
	05 01 505 MORSETTO CARBURATORE PRATIC	100	1,5	5,5	8
	05 01 506 MORSETTO CARBURATORE CON GRANO MAGURA	100	1,5	5,5	8
	05 01 507 MORSETTO CON VITE IN TESTA	100	2	6	12
	05 01 540 MORSETTO VITE IN TESTA PER LEVA/AGRICOLO	50	3	8	16
	05 01 541 MORSETTO AGRICOLO DUE FORI	25	3	8	28
	05 01 508 MORSETTO CAMBIO VESPA CON PASTIGLIA	100	2	7	13
	05 01 509 MORSETTO CAMBIO APE MP	50	2	7	20
	05 01 530 REGOLATORE ESAGONALE DIAMETRO 5 ma	50	2,5	5	30
	05 01 531 REGOLATORE ESAGONALE DIAMETRO 6 ma	50	3	6	30
	05 01 532 REGOLATORE ESAGONALE DIAMETRO 7 ma	25	3	7	35
	05 01 533 REGOLATORE ESAGONALE DIAMETRO 8 ma	25	4	8	40
	05 01 536 REGOLATORE DIAMETRO 6 ma LEVE DOMINO CIAO	50	2,5	6	25
	05 01 545 REGOLATORE TENDIFILO BLOCCACAVO C/MORSETTO	10	3	6	50



MINUTERIE METALLICHE

ARTICOLO	DESCRIZIONE	CONFEZIONE	INTERNO	ESTERNO	LUNGHEZZA
			mm	mm	mm
05 01 510	CAPIGUAINA PER GUAINA RIVESTITA DIAMETRO 3,9	100	4	4,5	11
05 01 516	CAPIGUAINA PER GUAINA RIVESTITA DIAMETRO 4,5	100	5,2	5,5	9
 05 01 517	CAPIGUAINA PER GUAINA RIVESTITA DIAMETRO 5	100	6.0	6,5	9
05 01 518	CAPIGUAINA PER GUAINA RIVESTITA DIAMETRO 6	100	7	8	10
05 01 519	CAPIGUAINA PER GUAINA RIVESTITA DIAMETRO 7	50	8	9	11
05 01 520	CAPIGUAINA PER GUAINA RIVESTITA DIAMETRO 8	50	9	10	11
05 01 521	BUSSOLETTA A GRADINO PER CAP DIAMETRO 4,5 - CICLO	100	6,2	7	9
05 01 522	BUSSOLETTA A GRADINO PER CAP DIAMETRO 5 - VESPA	100	7	8	13
 05 01 523	BUSSOLETTA A GRADINO PER CAP DIAMETRO 6 - FRENO	25	8	10	17
05 01 524	BUSSOLETTA A GRADINO PER CAP DIAMETRO 7	25	9	11	17
05 01 525	BUSSOLETTA A GRADINO PER CAP DIAMETRO 8	25	10	12	17
05 01 542	BUSSOLA A GRADINO	10	16	12	12
05 01 543	BUSSOLA A GRADINO	10	16	26	14
 05 01 526	BUSSOLA FRESATA PER CAP 4,5 - 5	100	7	10	13
 05 01 527	BUSSOLA LUNGHE MOTOCARRI APE	50	3	9	20
 05 01 514	MORSETTO FRENO CICLO SPORT	100	2	5	14
 05 01 515	MORSETTO FRENO CICLOMOTORE	50	3	6	16
 05 01 512	MORSETTO LEVA FRIZIONE GARELLI	50	2	8	18
 05 01 513	BARILOTTO FRESATO LEVE CIAO - GARELLI	50		8	16
 05 01 528	BARILOTTO FRESATO LEVA VESPA	100		8	8
 05 01 529	BARILOTTO FRESATO LEVA MOTO	100		9	9
 05 01 535	CUSTODIA LEVA DOMINO CIAO	100		9	11
05 01 575	FASCETTE A FILO STRINGITUBO BENZINA D 4x7 - 5x8	50			
05 01 576	FASCETTE A FILO STRINGITUBO BENZINA D 6x9	50			
05 01 577	FASCETTE A FILO STRINGITUBO BENZINA D 4x10	50			
 05 01 578	FASCETTE A FILO STRINGITUBO BENZINA D 6x12	50			

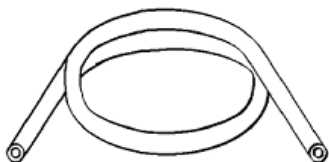

TUBI PLASTICI

ARTICOLO	DESCRIZIONE
04 01 585 (50 mt)	TUBO OLIO MISCELATORE (TRASPARENTE)
04 01 003 (50 mt)	TUBO OLIO MISCELATORE (TRASPARENTE)
04 01 012 (10 mt)	TUBO PER LIQUIDI ALIMENTARI (TRASPARENTE)
04 01 014 (10 mt)	TUBO PER LIQUIDI ALIMENTARI (TRASPARENTE) (BIANCO)
04 02 590 (10 mt)	TUBO PER BENZINA VERDE ALTA RESTENZA IDROCARBURI
04 02 594 (10 mt)	TUBO PER BENZINA VERDE ALTA RESTENZA IDROCARBURI
04 02 591 (10 mt)	TUBO PER BENZINA VERDE ALTA RESTENZA IDROCARBURI
04 02 592 (10 mt)	TUBO PER BENZINA VERDE ALTA RESTENZA IDROCARBURI
04 02 593 (10 mt)	TUBO PER BENZINA VERDE ALTA RESTENZA IDROCARBURI
04 02 596 (10 mt)	TUBO PER BENZINA VERDE ALTA RESTENZA IDROCARBURI
04 03 595 (5 mt)	TUBO PER BENZINA VERDE ALTA PRESSIONE (TELATO) DOPPIO (NERO BIANCO)

DIAMETRO	MATERIALE	APPLICAZIONE
2 x 5	PVC	
3 x 6	PVC	
12 x 16	ATOSSICO	
14 x 19	ATOSSICO	
4 x 7	ARI	GARELLI-CIAO
4 x 10	ARI	SCOOTER PIAGGIO
5 x 8	ARI	SCOOTER MINARELLI
6 x 9	ARI	MOTOCARRI APE
6 x 12	ARI	VESPA
6 x 10	ARI	NERO
5 x 12	ARI	MALAGUTI



MATASSE CAVO ACCIAIO

ARTICOLO	DESCRIZIONE
06 01 550	CORDINA CAVO ACCIO 19 CAPI ZINCATO ACCELERATORE
06 01 551	CORDINA CAVO ACCIO 19 CAPI ZINCATO CAMBIO
06 01 552	CORDINA CAVO ACCIO 19 CAPI ZINCATO FRIZIONE - FRENO
06 01 553	CORDINA CAVO ACCIO 19 CAPI ZINCATO FRIZIONE - FRENO
06 01 554	CORDINA CAVO ACCIO 19 CAPI ZINCATO FRENO
06 01 555	CORDINA CAVO ACCIO 19 CAPI ZINCATO FRENO
06 02 556	CORDINA CAVO TREFOLO 49 CAPI ZINCATO ACCELERATORE
06 02 559	CORDINA CAVO TREFOLO 49 CAPI ZINCATO CAMBIO
06 02 557	CORDINA CAVO TREFOLO 49 CAPI ZINCATO FRIZIONE - FRENO
06 02 558	CORDINA CAVO TREFOLO 49 CAPI ZINCATO FRIZIONE - FRENO
06 03 550	CORDINA CAVO TREFOLO 49 CAPI INOX ACCELERATORE

DIAMETRO	CONFEZIONE
1,2	10 - 50 - 100 mt
1,6	10 - 50 - 100 mt
1,9	10 - 50 - 100 mt
2,5	10 - 50 - 100 mt
3,0	10 - 50 - 100 mt
4,0	10 - 50 - 100 mt
1,25	10 - 50 - 100 mt
1,6	10 - 50 - 100 mt
1,9	10 - 50 - 100 mt
2,5	10 - 50 - 100 mt
1,25	10 - 50 - 100 mt



COMANDI FLESSIBILI STARTER



ARTICOLO	MARCA	DESCRIZIONE
	MALOSSI	
13 00 001		TRASMISSIONE STARTER SCOOTER
	APRILIA	
13 01 337		50 SCARABEO
13 01 338		50 AMICO-SR
13 01 025		TRASMISSIONE RAVE 125 RS
	YAMAHA	
13 64 027		COMANDO DECOMPRESSORE 600 XT TENERE 1991->
13 64 361		COMANDO DECOMPRESSORE 600 XT TENERE ->1990

SIMILE
271829
8214124
8214108
8114175
2WK1229200
2KF1229200



TRASMISSIONI CONTACHILOMETRI

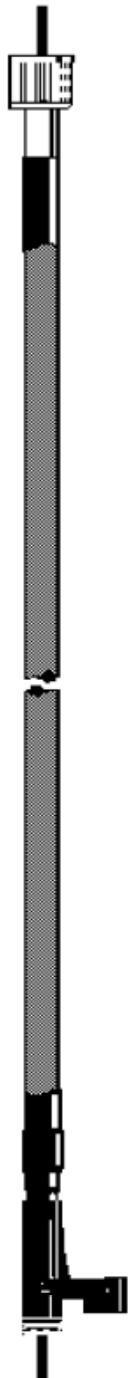

ARTICOLO	APPLICAZIONE	DESCRIZIONE	SIMILE
APRILIA			
MOTO			
07 01 712	50 RED ROSE	TRASMISSIONE CONTAKM (897mm)	8214042
07 01 724	50 RX	TRASMISSIONE CONTAKM (920mm)	8214054
07 01 021	50 RS 1999->	TRASMISSIONE CONTAKM (865mm)	8214181
07 01 602	50 AF1	TRASMISSIONE CONTAKM (880mm)	8214190
07 01 612	50 TUAREG 88-89	TRASMISSIONE CONTAKM (955mm)	8214046
07 01 608	50 ET-TURAEG 86	TRASMISSIONE CONTAKM (987mm)	8214028
07 01 610	125 ETX 86-87	TRASMISSIONE CONTAKM (960mm)	8114051
07 01 614	125-250 RALLY	TRASMISSIONE CONTAKM (1090mm)	8114125
07 01 616	125-250 RALLY	TRASMISSIONE CONTAKM (1073mm)	8114090
07 01 618	125 AF1 SINTESI	TRASMISSIONE CONTAKM (862mm)	8114155
07 01 604	125 AF1 REPLICA	TRASMISSIONE CONTAKM (950mm)	8114116
07 01 606	125 TUAREG TWIN	TRASMISSIONE CONTAKM (965mm)	8114112
07 01 020	125 EXTREMA 1997->	TRASMISSIONE CONTAKM (769mm)	8114334
07 01 726	125 AF1 SINTESI	TRASMISSIONE CONTAKM (933mm)	8114170
07 01 728	125-250 RALLY	TRASMISSIONE CONTAKM (1180mm)	8114136
07 01 730	125 RX	TRASMISSIONE CONTAKM (1005mm)	8114187
07 01 732	125 PEGASO	TRASMISSIONE CONTAKM (880mm)	8114186
07 01 733	125 PEGASO	TRASMISSIONE CONTAKM (890mm)	8114185
SCOOTER			
07 01 624	50 RALLY LC	TRASMISSIONE CONTAKM (990mm)	8214165
07 01 683	50 SONIC	TRASMISSIONE CONTAKM (902mm)	8214173
07 01 722	50 AMICO ->1992	TRASMISSIONE CONTAKM (910mm)	8214070
07 01 762	50 AMICO SPORT	TRASMISSIONE CONTAKM (945mm)	8214110
07 01 763	50/125 HABANA	TRASMISSIONE CONTAKM (960mm)	8214210
07 01 766	50 SR-URBAN KID	TRASMISSIONE CONTAKM (906mm)	8214130
07 01 771	50 SR--WWW-STEALTH-DI TEK	TRASMISSIONE CONTAKM (900mm)	8214163
07 01 784	50 SCARABEO	TRASMISSIONE CONTAKM (923mm)	8214126
07 01 796	50 SR-GULLIVER->1996	TRASMISSIONE CONTAKM (935mm)	8214142
07 01 028	100 2 T SCARABEO	TRASMISSIONE CONTAKM (1004mm)	8214199
	100 4 T SCARABEO	TRASMISSIONE CONTAKM (1004mm)	8214208
	50 RALLY 1997->	TRASMISSIONE CONTAKM (1010mm)	8214158
07 01 798	50 AMICO 1997->	TRASMISSIONE CONTAKM (1010mm)	8214169
	125/150 LEONARDO	TRASMISSIONE CONTAKM (1010mm)	8114357
	125/150 SCARABEO	TRASMISSIONE CONTAKM (1010mm)	8114357
07 01 075	125 SPORT CITY UNO	TRASMISSIONE CONTAKM (956mm)	AP858542
BENELLI			
07 04 633	125-150-250 VELVET	TRASMISSIONE CONTAKM (1008mm)	R53410041A0
07 04 679	K2 - 491	TRASMISSIONE CONTAKM (990mm)	R53410021AO/11AO
	K2	TRASMISSIONE CONTAKM (990mm)	R53410021AO
BETA			
07 05 729	50 ARK	TRASMISSIONE CONTAKM (950mm)	29142252
07 05 739	50 TEMPO 1995	TRASMISSIONE CONTAKM (910mm)	2914120052
07 05 741	50 CHRONO 502	TRASMISSIONE CONTAKM (945mm)	2914110052
CEV			
07 12 656	CICLOMOTORE	TRASMISSIONE CONTAKM (784mm)	N.D.
07 12 658	CICLOMOTORE	TRASMISSIONE CONTAKM (880mm)	N.D.
CAGIVA			
07 09 767	50 CITY	TRASMISSIONE CONTAKM (947mm)	Y00FA0016
07 09 740	50 COCIS	TRASMISSIONE CONTAKM (997mm)	58342
07 09 620	125 SST RUOTE LEGA	TRASMISSIONE CONTAKM (826mm)	33625
07 09 622	125 ALETTA ROSSA	TRASMISSIONE CONTAKM (951mm)	34884
07 09 626	125 ELEFANTRE	TRASMISSIONE CONTAKM (962mm)	51899
07 09 628	125 ALETTA ORO	TRASMISSIONE CONTAKM (844mm)	43184
07 09 630	125 FRECCIA C9	TRASMISSIONE CONTAKM (734mm)	55708
07 09 708	125 CRUISER	TRASMISSIONE CONTAKM (970mm)	51982
07 09 710	125 TAMANACO	TRASMISSIONE CONTAKM (1025mm)	60029
07 09 734	125 MITO (All Model)	TRASMISSIONE CONTAKM (650mm)	70130-66441



TRASMISSIONI CONTACHILOMETRI

ARTICOLO	APPLICAZIONE	DESCRIZIONE	SIMILE
DUCATI			
07 15 619	600 MOSTER	TRASMISSIONE CONTAKM (827mm)	40310082A
FANTIC			
07 16 634	125-240 TRIAL (Veglia)	TRASMISSIONE CONTAKM (355mm)	26616005150
07 16 636	125-240 TRIAL (Cev)	TRASMISSIONE CONTAKM (323mm)	35016005150
07 16 638	50 RAIDER	TRASMISSIONE CONTAKM (935mm)	23816005150
07 16 780	50 CABALLERO RC	TRASMISSIONE CONTAKM (1048mm)	41116005150
GILERA			
MOTO			
07 20 646	50 R1-RALLY	TRASMISSIONE CONTAKM (980mm)	339458
07 20 640	125-200-250 RV	TRASMISSIONE CONTAKM (910mm)	322623
07 20 642	125-200 RX-RTX	TRASMISSIONE CONTAKM (990mm)	322053
07 20 644	125 KK-KZ	TRASMISSIONE CONTAKM (748mm)	327238
07 20 648	125 RC-RALLY	TRASMISSIONE CONTAKM (1088mm)	329741
07 20 650	125 R1	TRASMISSIONE CONTAKM (1054mm)	337339
07 20 652	125 XR1-XR2	TRASMISSIONE CONTAKM (986mm)	941193
07 20 654	125 MX1-MXR	TRASMISSIONE CONTAKM (778mm)	343673
07 20 668	125 RC TOP RALLY	TRASMISSIONE CONTAKM (1055mm)	324709
07 20 716	125 SP 01	TRASMISSIONE CONTAKM (698mm)	943214
H S C			
07 25 674	50 SP ->1993	TRASMISSIONE CONTAKM (860mm)	44830GWO000
07 25 754	50 SP 1994->	TRASMISSIONE CONTAKM (888mm)	44830GZ0000
	50 SC 01 ->1993	TRASMISSIONE CONTAKM (888mm)	44830GAH000
	50 ZX->1994	TRASMISSIONE CONTAKM (888mm)	44830GBL000
	50 ZX ->1993	TRASMISSIONE CONTAKM (888mm)	44830GAH700
HONDA			
07 25 633	50 WALLAROO	TRASMISSIONE CONTAKM (920mm)	44830TG8600
07 25 714	50 VISION-LEAD	TRASMISSIONE CONTAKM (1102mm)	44830GY1921
07 25 723	50 X8R	TRASMISSIONE CONTAKM (1068mm)	44830GCM900
07 25 753	50 SKY	TRASMISSIONE CONTAKM (960mm)	44830GCG930
07 25 778	50 BALI	TRASMISSIONE CONTAKM (1170mm)	44830GAV700
07 25 791	50 SFX	TRASMISSIONE CONTAKM (930mm)	44830GBM750
07 25 782	125 SPACY	TRASMISSIONE CONTAKM (1130mm)	77830KV8750
07 25 001	600 HORNET	TRASMISSIONE CONTAKM (895mm)	44830MBZ610
07 25 623	125-150 @ THEC	TRASMISSIONE CONTAKM (1030mm)	44830KGF900
	600 VT	TRASMISSIONE CONTAKM (1030mm)	44830MR1000
07 25 660	NS-NSR 125 F	TRASMISSIONE CONTAKM (875mm)	44830KR1760
	NS- NSR 125 R	TRASMISSIONE CONTAKM (875mm)	44830KR1860
	CBR 600	TRASMISSIONE CONTAKM (875mm)	44830MN4000
07 25 662	MTX 125 R	TRASMISSIONE CONTAKM (910mm)	44830KS3900
	XL 600 TRANSALP	TRASMISSIONE CONTAKM (910mm)	44830MM9000
	XVR 650 AFRICA TWIN	TRASMISSIONE CONTAKM (910mm)	44830MM9000
	NX 650 DOMINETOR	TRASMISSIONE CONTAKM (910mm)	44830MM9000
07 25 664	XL 125/200 6V	TRASMISSIONE CONTAKM (955mm)	44830MG7000
	XL 600 RM/LM	TRASMISSIONE CONTAKM (955mm)	44860MK5000
	XL 600 R	TRASMISSIONE CONTAKM (955mm)	44860MG7000
	XR 650	TRASMISSIONE CONTAKM (955mm)	44860GRT700
07 25 666	50 SH 1996->	TRASMISSIONE CONTAKM (947mm)	44830GBY910
	125-150 SH	TRASMISSIONE CONTAKM (947mm)	44830KPR900
	250 JAZZ	TRASMISSIONE CONTAKM (947mm)	44830KS4010
	250 CN	TRASMISSIONE CONTAKM (947mm)	44830KS4620
	750 VFR ->1987	TRASMISSIONE CONTAKM (947mm)	44830MJ6000
07 25 697	750 VFR 1988->	TRASMISSIONE CONTAKM (947mm)	44830ML7920
	250 FORESIGHT	TRASMISSIONE CONTAKM (1068mm)	44830KEJ900
07 25 697	125/150 PANTHEON	TRASMISSIONE CONTAKM (1068mm)	44830KEJ900
	KAWASAKI		
07 27 704	600 KLR	TRASMISSIONE CONTAKM (1000mm)	540011116

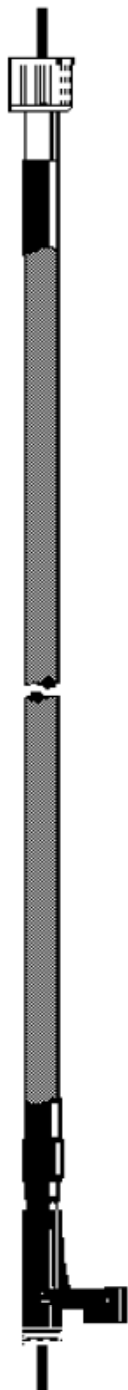



TRASMISSIONI CONTACHILOMETRI

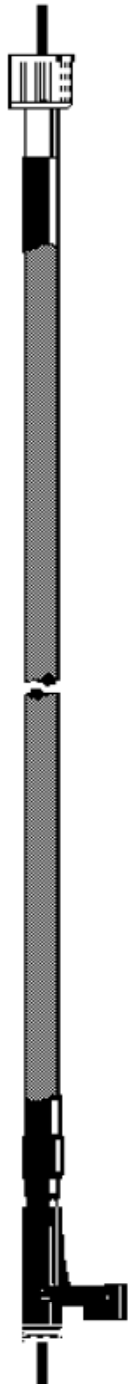

ARTICOLO	APPLICAZIONE	DESCRIZIONE	SIMILE
KYMCO			
07 28 701	50-125-150 DINK ->2005	TRASMISSIONE CONTAKM(910mm)	00151914
07 28 635	{ 50 FILLY 50/125/200 DINK 2006->	TRASMISSIONE CONTAKM(955mm) TRASMISSIONE CONTAKM(955mm)	00151615 00151615
07 28 622	125-150-250 GRAN DINK	TRASMISSIONE CONTAKM (928mm)	00151171
07 28 617	50-125-150 PEOPLE	TRASMISSIONE CONTAKM (937mm)	00151303
07 28 030	{ 50-125-200 S PEOPLE 20-125 AGILITY Ruota 16	TRASMISSIONE CONTAKM (970mm) TRASMISSIONE CONTAKM (970mm)	00151323 00151323
07 28 037	250 LC PEOPLE	TRASMISSIONE CONTAKM (989mm)	00156392
07 28 031	250/300 S PEOPLE	TRASMISSIONE CONTAKM (1040mm)	00156398
07 28 779	50 SNIPER-NEW DUKE	TRASMISSIONE CONTAKM (915mm)	00151603
07 28 637	50-125-150 HEROISM	TRASMISSIONE CONTAKM (1090mm)	00151720
07 25 666	125/150 VIVIO - MOVIE (vedi HONDA)	TRASMISSIONE CONTAKM (947mm)	00151117
07 28 645	{ 50 AGILITY Ruota 12 50-125-150-250 B&W All Mode	TRASMISSIONE CONTAKM (1015mm) TRASMISSIONE CONTAKM (1015mm)	00151080 00151913
07 54 698	{ 50 FEVER ZX 50 KB - 50 K12 (Vedi PEUGEOT) 125/150 MOVIE XK	TRASMISSIONE CONTAKM (983mm) TRASMISSIONE CONTAKM (983mm) TRASMISSIONE CONTAKM (983mm)	00151821 00151821 00151821
ITALJET			
07 30 745	50 FORMULA	TRASMISSIONE CONTAKM(1050mm)	3380060
07 30 750	50 BAZOOKA	TRASMISSIONE CONTAKM (1083mm)	3312308
07 30 752	50 REPORTER	TRASMISSIONE CONTAKM (1083mm)	9500238
07 30 768	50 PISTA-SCOOP	TRASMISSIONE CONTAKM (910mm)	3322304
INNOCENTI			
07 34 700	125-150-175 LI	TRASMISSIONE CONTAKM (1154mm)	00611868
07 34 702	DL-LI 3a Serie	TRASMISSIONE CONTAKM (1154mm)	00611125
MALAGUTI			
07 16 638	MALAGUTI FIFTY	TRASMISSIONE CONTAKM (935mm)	N.D.
07 38 009	50 CIAK	TRASMISSIONE CONTAKM (1000mm)	17814400
07 38 795	50 CROSSER	TRASMISSIONE CONTAKM(1013mm)	17810700
07 38 787	50 CENTRO SL	TRASMISSIONE CONTAKM (968mm)	17808900
07 38 797	50 CENTRO	TRASMISSIONE CONTAKM (978mm)	17808600
07 38 657	50 F10 1997->	TRASMISSIONE CONTAKM (942mm)	17811600
07 38 764	50 F10 ->1996	TRASMISSIONE CONTAKM (0937mm)	17808100
07 38 651	{ 50 F12 1998-> 50 F18	TRASMISSIONE CONTAKM (1057mm) TRASMISSIONE CONTAKM (1057mm)	17813300 17815100
07 38 799	{ 50 F12 PHANTOM -> 1997 50 F15 FIREFOX ->1997	TRASMISSIONE CONTAKM (1050mm) TRASMISSIONE CONTAKM (1050mm)	17809400 17811400
07 38 649	125/250 MADISON	TRASMISSIONE CONTAKM (905mm)	17814300
MOTO MORINI			
07 47 620	125H-250 1-2C	TRASMISSIONE CONTAKM (800mm)	430319
07 47 677	350 SPORT - GT	TRASMISSIONE CONTAKM (812mm)	460309
07 47 678	350 KANGURO	TRASMISSIONE CONTAKM (986mm)	430648
PEUGEOT			
07 54 625	{ 50 SQUAB 50-100 TREKKER	TRASMISSIONE CONTAKM (1000mm) TRASMISSIONE CONTAKM (1000mm)	734683 736721
07 54 626	50 VIVACITY	TRASMISSIONE CONTAKM (1035mm)	739602
07 54 659	50 - 100 ELISEO	TRASMISSIONE CONTAKM (1036mm)	740993
07 54 674	50 SP - 50 ST	TRASMISSIONE CONTAKM (860mm)	710780-710784
07 54 676	50 RAPIDO	TRASMISSIONE CONTAKM (1000mm)	720442
07 54 698	50-80 SC METROPOLIS	TRASMISSIONE CONTAKM (983mm)	705609
07 54 703	50-100 SPEEDFIGHT	TRASMISSIONE CONTAKM (1102mm)	736610
07 54 748	50-125 GEO SV	TRASMISSIONE CONTAKM (1068mm)	724335
07 54 774	50 GEO SV mod T	TRASMISSIONE CONTAKM (915mm)	729077
07 54 785	50 ZENIT	TRASMISSIONE CONTAKM (996mm)	732614
07 54 789	50 BUXI-SPEEDAKE	TRASMISSIONE CONTAKM (1045mm)	736673



TRASMISSIONI CONTACHILOMETRI

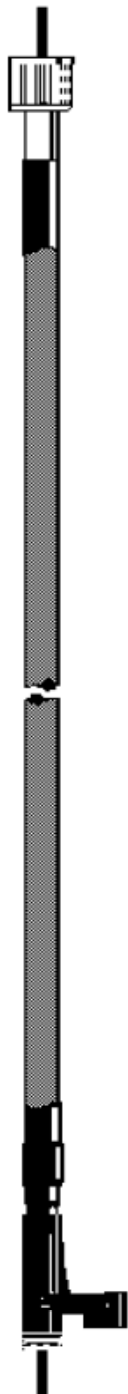

ARTICOLO	APPLICAZIONE	DESCRIZIONE	SIMILE
PIAGGIO			
07 56 758	ZIP 50 I-IIs	TRASMISSIONE CONTAKM (930mm)	271837
07 56 776	{ ZIP 50 FAST RAIDER ->1995 TYPHOON-NRG 50 (GILERA)	TRASMISSIONE CONTAKM (940mm)	272340
		TRASMISSIONE CONTAKM (940mm)	574331-272353
07 56 755	{ ZIP 50 RST 1994-> (Gommone) ZIP 50 1997-> - RST ->1996	TRASMISSIONE CONTAKM (953mm)	574331
		TRASMISSIONE CONTAKM (953mm)	563090-581682
07 56 669	ZIP 50 1998-2000	TRASMISSIONE CONTAKM (1026mm)	581682
07 56 610	ZIP 50 2000 ->	TRASMISSIONE CONTAKM (953mm)	581321
07 56 707	ZIP 50 SP	TRASMISSIONE CONTAKM (1073mm)	582507-561997
07 56 788	FREE 50	TRASMISSIONE CONTAKM (844mm)	272352
07 56 615	FREE 50 mod PT	TRASMISSIONE CONTAKM (905mm)	582414
07 56 765	LIBERTY 50-125	TRASMISSIONE CONTAKM (945mm)	560973
07 56 006	LIBERTY 50-125 RST - 50-125-150 4T	TRASMISSIONE CONTAKM (939mm)	647804-600540
07 56 616	LIBERTY 50-125 mod PT	TRASMISSIONE CONTAKM (960mm)	582665
07 56 033	LIBERTY 50-125 RST mod PT	TRASMISSIONE CONTAKM (983mm)	647803
07 56 026	LIBERTY 125-200-250 RST/SPORT	TRASMISSIONE CONTAKM (983mm)	647806-56457/R
07 56 696	{ SFERA 50 ->1995 VESPA 125-150 PX DISCO	TRASMISSIONE CONTAKM (1009mm)	266848
		TRASMISSIONE CONTAKM (1009mm)	563796
07 56 792	SFERA 50 RST	TRASMISSIONE CONTAKM (1043mm)	562403
07 56 007	BEVERLY125-250 RST 2004->	TRASMISSIONE CONTAKM (1029mm)	648992
07 56 008	BEVERLY 500 2002->	TRASMISSIONE CONTAKM (1029mm)	599685
07 56 029	FLY 50-125-150	TRASMISSIONE CONTAKM (1014mm)	600315
07 56 757	VESPA 50-125 ET2-ET4	TRASMISSIONE CONTAKM (1109mm)	56116R
07 56 034	VESPA 50-125-150 LX ->2008	TRASMISSIONE CONTAKM (1084mm)	56307R
07 56 038	VESPA 125-150 S	TRASMISSIONE CONTAKM (1104mm)	650836
07 56 743	VESPA GRAN TURISMO 125-200 ->2008	TRASMISSIONE CONTAKM (1150mm)	599350
07 56 039	VESPA GRAN TURISMO 125-200 2009->	TRASMISSIONE CONTAKM (1149mm)	650849
07 56 040	VESPA GRAN TURISMO 125-200 VINTAGE	TRASMISSIONE CONTAKM (1096mm)	650837
07 56 041	VESPA 125-150 LX	TRASMISSIONE CONTAKM (1106mm)	56307R
07 56 042	VESPA 125-150 LX VINTAGE	TRASMISSIONE CONTAKM (1164mm)	650838
07 56 760	QUARTZ 50 - SKIPPER 125-150 ->1997	TRASMISSIONE CONTAKM (1009mm)	268263
07 56 601	SKIPPER 125-150 1998->	TRASMISSIONE CONTAKM (1030mm)	560243
07 56 790	HEXAGON 125-150 ->1997	TRASMISSIONE CONTAKM (1097mm)	274643
07 56 695	HEXAGON 250 GT - 125-180 1998->	TRASMISSIONE CONTAKM (1109mm)	561279
07 56 653	HEXAGON 125-150 2001->(Ruota 12")	TRASMISSIONE CONTAKM (1080mm)	583185
07 56 012	X8 200	TRASMISSIONE CONTAKM (1022mm)	647029
GILERA - SCOOTER			
07 56 699	RUNNER 50	TRASMISSIONE CONTAKM (986mm)	561710
07 56 613	RUNNER 50 RST	TRASMISSIONE CONTAKM (970mm)	581848
07 56 731	RUNNER 125-180 ->2000	TRASMISSIONE CONTAKM (999mm)	563412
07 56 614	RUNNER 125 4T-125-180 2T 2001->	TRASMISSIONE CONTAKM (1024mm)	582413
07 56 705	STALKER 50	TRASMISSIONE CONTAKM (965mm)	561152
07 56 629	TYPHOON-NRG 50 EXTREME	TRASMISSIONE CONTAKM (990mm)	581287
07 56 776	TYPHOON-NRG 50 STORM ->1995	TRASMISSIONE CONTAKM (940mm)	272353
07 56 794	TYPHOON-NRG 50-125 1996->	TRASMISSIONE CONTAKM (958mm)	563621
PIAGGIO VINTAGE			
07 56 694	CIAO-SI-BOSS	TRASMISSIONE CONTAKM (838mm)	187423
07 56 746	VESPA 50 FL	TRASMISSIONE CONTAKM (960mm)	266321
07 56 680	VESPA 50/125 PK	TRASMISSIONE CONTAKM (940mm)	195407
07 56 682	VESPA 50/125 (Ghiera)	TRASMISSIONE CONTAKM (888mm)	71059
07 56 684	VESPA 50-125 ET3	TRASMISSIONE CONTAKM (888mm)	183582
07 56 053	VESPA125/150 51-59	TRASMISSIONE CONTAKM (1030mm)	021151
07 56 692	VESPA 125-150-GL - 180-200 Rally	TRASMISSIONE CONTAKM (1068mm)	99011
07 56 054	VESPA 150 GS	TRASMISSIONE CONTAKM (1101mm)	024190
07 56 056	VESPA 160 GS	TRASMISSIONE CONTAKM (935mm)	057045
07 56 056	VESPA 180 SS	TRASMISSIONE CONTAKM (935mm)	057045
07 56 055	VESPA 150 VBA 59-62	TRASMISSIONE CONTAKM (1004mm)	084741
07 56 061	VESPA 150 VBA 59-62 (cavo D 2,5)	TRASMISSIONE CONTAKM (1009mm)	084741
07 56 686	VESPA 125-150-200 PX	TRASMISSIONE CONTAKM (1032mm)	174161
07 56 690	VESPA 125-150-200 ARCO/COSA	TRASMISSIONE CONTAKM (1040mm)	179271-229358



TRASMISSIONI CONTACHILOMETRI

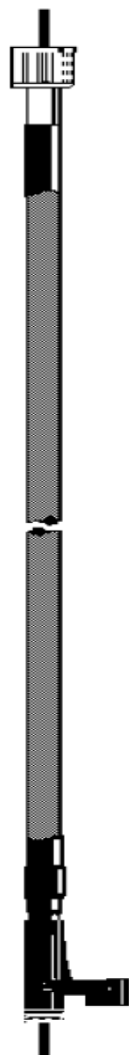

ARTICOLO	APPLICAZIONE	DESCRIZIONE	SIMILE
PIAGGIO MOTOCARRI APE			
07 56 718	APE CAR	TRASMISSIONE CONTAKM (1174mm)	129106
07 56 720	APE TM	TRASMISSIONE CONTAKM (2575mm)	194371
07 56 772	APE 50 TM	TRASMISSIONE CONTAKM (1118mm)	188636
07 56 060	QUARGO	TRASMISSIONE CONTAKM (3668mm)	645563
SIAM			
07 25 666	50 BIRD (Vedi HONDA)	TRASMISSIONE CONTAKM (947mm)	N.D.
S Y M			
07 25 623	125 ATTILA (Vedi HONDA)	TRASMISSIONE CONTAKM (1030mm)	N.D.
SUZUKI			
07 61 706	600 DR	TRASMISSIONE CONTAKM (990mm)	34910-14A10
YAMAHA MOTO			
07 64 655	XT 600 TTR	TRASMISSIONE CONTAKM (973mm)	5CHH3550010
07 64 670	XT 600 TENERE 4 VAL XT 600 TENERE AVV ELET	TRASMISSIONE CONTAKM (981mm)	34L8355000
		TRASMISSIONE CONTAKM (981mm)	48Y8355000
07 64 672	DT 125 TENERE	TRASMISSIONE CONTAKM (1000mm)	34X8355000
	XT 600 TENERE 1988->	TRASMISSIONE CONTAKM (1000mm)	3AJ8355000
	TDM 850 1991-1995	TRASMISSIONE CONTAKM (1000mm)	1FK83550011
YAMAHA SCOOTER			
07 41 756	50 CR Z	TRASMISSIONE CONTAKM (880mm)	3WNH355000
	50 TARGET	TRASMISSIONE CONTAKM (880mm)	3GFH355000
07 41 744	50 CT-SORRISO	TRASMISSIONE CONTAKM (1056mm)	1NTH355000
07 41 781	50 FORTE	TRASMISSIONE CONTAKM (934mm)	4WGH3550R1
07 41 769	50 TRACK	TRASMISSIONE CONTAKM (966mm)	4YBH355000
	50 OVETTO-NEOS	TRASMISSIONE CONTAKM (966mm)	5ADH355000
07 41 639	50 FLIPPER	TRASMISSIONE CONTAKM (935mm)	5EUH355000
07 41 715	50 AEROX-NITRO ->2001	TRASMISSIONE CONTAKM (1026mm)	5BRH355000
07 41 647	125 FLAME	TRASMISSIONE CONTAKM (1150mm)	4KCH35500
07 41 010	50 AEROX-NITRO 2002->	TRASMISSIONE CONTAKM (981mm)	5PUH3550001
	125 FLAME F	TRASMISSIONE CONTAKM (981mm)	5FMH355000
	125 FLAME R	TRASMISSIONE CONTAKM (981mm)	4HPH355000
07 41 742	50 BOOSTER	TRASMISSIONE CONTAKM (908mm)	3VLH355000
07 41 786	50 BOOSTER-NG	TRASMISSIONE CONTAKM (906mm)	4SBH355000
07 41 770	50 BOOSTER R-SPIRIT-ROAD-BWS	TRASMISSIONE CONTAKM (950mm)	4PAH355000
	50 EVOLIS-FIZZ	TRASMISSIONE CONTAKM (950mm)	4CUH355000
	250 MAJESTY	TRASMISSIONE CONTAKM (950mm)	4HC8355000
07 41 749	125-150 SKILINER-MAJESTY	TRASMISSIONE CONTAKM (1026mm)	5DSH355000



FLESSIBILI CONTACHILOMETRI PIAGGIO



ARTICOLO	APPLICAZIONE	DESCRIZIONE	SIMILE
09 56 685	VESPA 50-125 ET3	FLESSIBILE CONTAKM (888mm)	183581
09 56 759	50 ZIP-I-Is	FLESSIBILE CONTAKM (920mm)	269063
09 56 681	50 ZIP FAST R-50-125 PK	FLESSIBILE CONTAKM (940mm)	270978-195409
09 56 775	50 ZIP 96	FLESSIBILE CONTAKM (949mm)	273821
09 56 751	50 ZIP 1997->	FLESSIBILE CONTAKM (956mm)	561996
09 56 777	50 TYPHOON NRG	FLESSIBILE CONTAKM (958mm)	298745
09 56 761	50 QUARTZ-SFERA	FLESSIBILE CONTAKM (1009mm)	268264
09 56 689	VESPA 125-150-200 PX	FLESSIBILE CONTAKM (1020mm)	229357-179272
09 56 687	VESPA 125-150-200 PX	FLESSIBILE CONTAKM (1032mm)	174160
09 56 691	125-150-200 COSA	FLESSIBILE CONTAKM (1040mm)	229357
09 56 693	VESPA 125-150 GL	FLESSIBILE CONTAKM (1068mm)	99014
09 56 747	VESPA ET2-ET4	FLESSIBILE CONTAKM (1112mm)	561806
09 56 719	APE CAR	FLESSIBILE CONTAKM (1174mm)	129558
09 56 773	APE 50 TM	FLESSIBILE CONTAKM (2118mm)	188637
09 56 721	APE TM	FLESSIBILE CONTAKM (2575mm)	194372



TRASMISSIONI CONTAGIRI

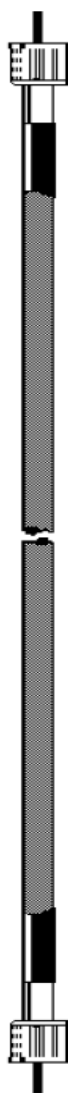

ARTICOLO	APPLICAZIONE	DESCRIZIONE	SIMILE
APRILIA			
08 01 601	50 ET 87-88	TRASMISSIONE CONTAGIRI (852mm)	8214035
08 01 603	50 AF1-FUTURA	TRASMISSIONE CONTAGIRI (934mm)	8214030
08 01 605	125 AF1 REPLICA	TRASMISSIONE CONTAGIRI (936mm)	8114114
08 01 607	125 ETX 85-88	TRASMISSIONE CONTAGIRI (932mm)	8114100
08 01 609	50 ET-TUAREG 86	TRASMISSIONE CONTAGIRI (845mm)	8214024
08 01 611	125 TUAREG 88	TRASMISSIONECONTAGIRI (1000mm)	8114072
08 01 613	50 TUAREG 87-89	TRASMISSIONE CONTAGIRI (895mm)	8214044
08 01 621	50 RX 91-00	TRASMISSIONE CONTAGIRI (800mm)	8214081
08 01 713	50 RED ROSE	TRASMISSIONE CONTAGIRI (897mm)	8214041
08 01 725	50 RX	TRASMISSIONE CONTAGIRI (800mm)	8214053
08 01 727	125 AF1 SINTESI	TRASMISSIONE CONTAGIRI (935mm)	8114168
08 01 737	50 RALLY 1990	TRASMISSIONE CONTAGIRI (892mm)	8214059
CAGIVA			
08 09 623	125 ALETTA ROSSA	TRASMISSIONE CONTAGIRI (833mm)	34882
08 09 627	125 ELEFANTRE	TRASMISSIONE CONTAGIRI (796mm)	51915
08 09 629	125 ALETTA ORO	TRASMISSIONE CONTAGIRI (770mm)	44282
08 09 631	125 FRECCIA C9	TRASMISSIONE CONTAGIRI (715mm)	55710
08 09 709	125 CRUISER	TRASMISSIONE CONTAGIRI (763mm)	54944
08 09 711	50 COCIS-125 TAMANACO	TRASMISSIONE CONTAGIRI (812mm)	58344
08 09 735	125 MITO	TRASMISSIONE CONTAGIRI (630mm)	66492
GILERA			
08 20 641	125-200-250 RV	TRASMISSIONE CONTAGIRI (912mm)	322626
08 20 643	125-200 RX-RTX	TRASMISSIONE CONTAGIRI (783mm)	322058
08 20 645	125 KK-KZ	TRASMISSIONE CONTAGIRI (748mm)	327235
08 20 653	125 XR1-XR2	TRASMISSIONE CONTAGIRI (773mm)	941198
08 20 655	125 MX1-MXR	TRASMISSIONE CONTAGIRI (828mm)	343672
08 20 717	125 SP 01	TRASMISSIONE CONTAGIRI (838mm)	943213
HONDA			
08 25 663	125 NS F	TRASMISSIONE CONTAGIRI (895mm)	37260KR1760
08 25 665	600 XL R	TRASMISSIONE CONTAGIRI (570mm)	37260KB7010
08 25 667	125-200 XL6V	TRASMISSIONE CONTAGIRI (830mm)	37260KB9010
YAMAHA			
08 64 671	XT 600 TENERE AVV ELET XT 600 TENERE 4 VAL	TRASMISSIONE CONTAGIRI (610mmk)	1VJ8356000
08 64 673		TRASMISSIONE CONTAGIRI (610mm)	34L8356000
	600 XT TENERE 125 DT TENERE	TRASMISSIONE CONTAGIRI (660mm)	3AJ8356000
		TRASMISSIONE CONTAGIRI (810mm)	34X8356000



TRASMISSIONI FRENO ANTERIORE

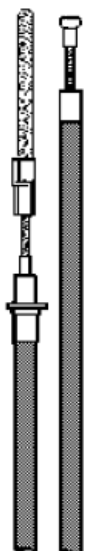

ARTICOLO	APPLICAZIONE	DESCRIZIONE	SIMILE
APRILIA			
10 01 362	50 SCARABEO	TRASMISSIONE FRENO ANTERIORE	8214120
HONDA			
10 25 480	50 SH	TRASMISSIONE FRENO ANTERIORE	45450GJ4760
MALAGUTI			
10 38 414	50 CENTRO	TRASMISSIONE FRENO ANTERIORE	04802603
PEUGEOT			
10 54 410	50 METROPOLIS	TRASMISSIONE FRENO ANTERIORE	705218
10 54 411	50 GEO SV	TRASMISSIONE FRENO ANTERIORE	724329
10 54 483	50 RAPIDO	TRASMISSIONE FRENO ANTERIORE	720441
10 54 488	50 ST	TRASMISSIONE FRENO ANTERIORE	712095
PIAGGIO			
10 56 432	50 ZIP	TRASMISSIONE FRENO ANTERIORE	269657
10 56 440	50 SFERA	TRASMISSIONE FRENO ANTERIORE	268195
YAMAHA			
10 41 349	50 CT-SORRISO	TRASMISSIONE FRENO ANTERIORE	1NTF634100
10 41 422	50 BOOSTER	TRASMISSIONE FRENO ANTERIORE	3VLF631000



TRASMISSIONI FRENO POSTERIORE

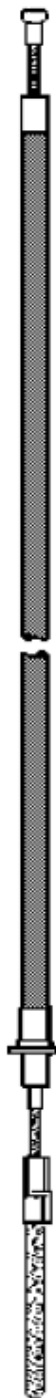

ARTICOLO	APPLICAZIONE	DESCRIZIONE	SIMILE
APRILIA			
11 01 043	{ 50 SCARABEO 2T/4T 2005-> 100 4T SCARABEO 2005->	TRASMISSIONE FRENO POSTERIORE	8214206
11 01 045	100 2T SCARABEO	TRASMISSIONE FRENO POSTERIORE	8214206
11 01 339	50 AMICO LX	TRASMISSIONE FRENO POSTERIORE	8114395
11 01 363	50 SCARABEO ->2005	TRASMISSIONE FRENO POSTERIORE	8214104
11 01 376	AMICO SR 50 RALLY-GULLIVER	TRASMISSIONE FRENO POSTERIORE	8214123
11 01 442	50 AMICO	TRASMISSIONE FRENO POSTERIORE	8214131
			8214064
HONDA			
11 25 347	50 BALI	TRASMISSIONE FRENO POSTERIORE	43450GAV700
11 54 461	50 GP-SX (HSC)(PEUGEOT)	TRASMISSIONE FRENO POSTERIORE	N.D.
11 25 481	{ 50 SKI 50 SH ->1995	TRASMISSIONE FRENO POSTERIORE	43450GCG930
		TRASMISSIONE FRENO POSTERIORE	43450GJ4760
11 25 413	50 SH 1996 ->	TRASMISSIONE FRENO POSTERIORE	43450GBY910
MALAGUTI			
11 38 400	50 CENTRO	TRASMISSIONE FRENO POSTERIORE	04802503
11 38 402	50 F 10	TRASMISSIONE FRENO POSTERIORE	04801303
11 38 403	50 F 12 PHANTOM	TRASMISSIONE FRENO POSTERIORE	04802903
11 38 416	50 CROSSER	TRASMISSIONE FRENO POSTERIORE	04803003
PEUGEOT			
11 54 448	50-125 GEO SV	TRASMISSIONE FRENO POSTERIORE	724328
11 54 461	50 METROPOLIS SC	TRASMISSIONE FRENO POSTERIORE	705219
11 54 482	50 ST - RAPIDO	TRASMISSIONE FRENO POSTERIORE	712094
PIAGGIO - GILERA			
11 56 433	{ ZIP 50 ZIP 50 FAST RAIDER	TRASMISSIONE FRENO POSTERIORE	269656
		TRASMISSIONE FRENO POSTERIORE	271853
11 56 390	SFERA 50 1996->	TRASMISSIONE FRENO POSTERIORE	273666
11 56 441	{ SFERA 50 ->1995 QUARTZ 50	TRASMISSIONE FRENO POSTERIORE	266213
		TRASMISSIONE FRENO POSTERIORE	266213
11 56 334	{ FREE 50 2001-> LIBERTY 50	TRASMISSIONE FRENO POSTERIORE	560006
		TRASMISSIONE FRENO POSTERIORE	560006
11 56 371	FREE 50 ->2000	TRASMISSIONE FRENO POSTERIORE	269002
11 56 366	{ LIBERTY 125 mod PT RST RUNNER 125-180 2T GILERA	TRASMISSIONE FRENO POSTERIORE	600561
		TRASMISSIONE FRENO POSTERIORE	563753
11 56 343	VESPA 50 ET2	TRASMISSIONE FRENO POSTERIORE	562424
11 56 344	VESPA 125 ET4	TRASMISSIONE FRENO POSTERIORE	564217
11 56 372	HEXAGON (All model)	TRASMISSIONE FRENO POSTERIORE	564107
11 56 343	RUNNER 50 GILERA	TRASMISSIONE FRENO POSTERIORE	562424
11 56 370	{ STORM 50 GILERA TYPHOON 50 GILERA 1997 ->	TRASMISSIONE FRENO POSTERIORE	270993
		TRASMISSIONE FRENO POSTERIORE	560711
YAMAHA			
11 41 423	{ 50 BOOSTER-R ->2001 50 BOOSTER NG-ROCHET	TRASMISSIONE FRENO POSTERIORE	3VLF635100
		TRASMISSIONE FRENO POSTERIORE	4SBF635100
11 41 385	50 BOOSTER-R 2002->	TRASMISSIONE FRENO POSTERIORE	5JHF635100
11 41 430	50 OVETTO-NEOS	TRASMISSIONE FRENO POSTERIORE	5ADF635100
11 41 304	50 CR Z-TARGET	TRASMISSIONE FRENO POSTERIORE	3GFF635100
11 41 425	50 CT-SORRISO	TRASMISSIONE FRENO POSTERIORE	1NTF635100



TRASMISSIONI ACCELERATORE



ARTICOLO	APPLICAZIONE	DESCRIZIONE	SIMILE
APRILIA - MOTO			
12 01 471	50 ET 85-88	TRASMISSIONE ACCELERATORE	8214023
12 01 326	50 RED ROSE	TRASMISSIONE ACCELERATORE	8214039
12 01 329	50 RX 91-2000	TRASMISSIONE ACCELERATORE	8214079
12 01 493	50 AF1	TRASMISSIONE ACCELERATORE	8214029
12 01 335	125 ETX-TUAREG 1988->	TRASMISSIONE ACCELERATORE	8114203
12 01 444	125 ETX-TUAREG ->1987	TRASMISSIONE ACCELERATORE	8114050
12 01 367	125 AF1 REPLICA	TRASMISSIONE ACCELERATORE	8114120
12 01 495	125 AF1 SINTESI	TRASMISSIONE ACCELERATORE	8114128
12 01 378	350 ETX	TRASMISSIONE ACCELERATORE	8114068
APRILIA - SCOOTER			
12 01 035	50 2T SCARABEO 2005 -> (PIAGGIO)	TR ACCELERATORE ALTO	N.D.
12 01 036	50 2T SCARABEO 2005 -> (PIAGGIO)	SERIE TRASMISSIONE GAS	8214242
12 01 015	125-150 SR	TR ACCELERATORE ALTO	8114380
12 01 417	50 2T SCARABEO ->2004	TRASMISSIONE ACCELERATORE	8214125
12 01 044	50 4T SCARABEO 2005->(PIAGGIO)	TRASMISSIONE ACCELERATORE	8214221
12 01 301	50 AMICO 90-92	TRASMISSIONE ACCELERATORE	8214069
12 01 397	50 RALLY-GULLIVER	TRASMISSIONE ACCELERATORE	8214160
12 01 317	{ 50 AMICO LX-SR	TRASMISSIONE ACCELERATORE	8214109
	{ 50 STEALTH	TRASMISSIONE ACCELERATORE	8214162
12 01 014	125-200 SPORTCITY	TRASMISSIONE ACCELERATORE	8114471
12 01 016	125-150-200 SCARABEO 2004->	TRASMISSIONE ACCELERATORE	8114476
CAGIVA			
12 09 351	125 MITO	TR ACCELERATORE ALTO	66172
12 09 325	125 CRUISER TAMANACO	TRASMISSIONE ACCELERATORE	54940
12 09 456	{ 125 SXT/82	TRASMISSIONE ACCELERATORE	35058
	{ 125 ALETTA ROSSA	TRASMISSIONE ACCELERATORE	39810
12 09 489	125 FRECCIA C9	TRASMISSIONE ACCELERATORE	56708
12 09 449	{ 125 ELEFANT II	TRASMISSIONE ACCELERATORE	47242
	{ 125 ALETTA ORO	TRASMISSIONE ACCELERATORE	47224
	{ 125 ALETTA ORO S2	TRASMISSIONE ACCELERATORE	51040
	{ 200 ELEFANT	TRASMISSIONE ACCELERATORE	48933
12 09 451	{ 250/350 SX 81	TRASMISSIONE ACCELERATORE	33019
	{ 250 SXT	TRASMISSIONE ACCELERATORE	37845
12 09 458	350 ALA ROSSA	TRASMISSIONE ACCELERATORE	39167
HONDA - MOTO			
12 25 499	125 NS-R	TR ACCELERATORE ALTO	17910KR1760
12 25 453	125 XL	TRASMISSIONE ACCELERATORE	N.D.
12 25 454	125/200 XL 6V	TRASMISSIONE ACCELERATORE	N.D.
12 25 473	125 NS	TRASMISSIONE ACCELERATORE	N.D.
12 25 475	125 MTX	TRASMISSIONE ACCELERATORE	17910KS3900
12 25 477	600 XL	TR ACCELERATORE TIRANTE	17910MG2010
12 25 478	600 XL	TR ACCELERATORE RITORNO	17920MG2010
HONDA - SCOOTER			
12 25 345	50 SH ->1995	TRASMISSIONE ACCELERATORE	17910GJ4760
12 25 346	50 BALI	TRASMISSIONE ACCELERATORE	17910GAV700
12 25 013	125-150 SH/NES@/DYLAN	TR GAS CARBURATORE ->2001	17910KGF900
12 25 046	125-150 SH/NES@/DYLAN	TR GAS CARBURATORE ->2006	17910KPZ861
12 25 047	125-150 SH/NES@/DYLAN	TR GAS INIEZIONE 2005->	17910KTF641
K T M			
12 29 332	COMANDO MAGURA	TRASMISSIONE ACCELERATORE	N.D.
MALAGUTI			
12 38 353	50 F 10	TR ACCELERATORE ALTO	03406903
12 38 419	50 F 12 PHANTOM	TR ACCELERATORE ALTO	03407803
12 38 418	50 F10-F12	TRASMISSIONE GAS COMPLETO	03408003
12 38 424	50 CROSSER	TRASMISSIONE GAS COMPLETO	03408103
12 38 427	50 CENTRO	TRASMISSIONE GAS COMPLETO	03501603
12 38 022	50 F12 EURO 2	TR COMANDO A CARBURATORE	03407803+03409303



TRASMISSIONI ACCELERATORE



ARTICOLO	APPLICAZIONE	DESCRIZIONE	SIMILE
MOTO GUZZI			
12 46 486	FLORIDA 35C-65C	TRASMISSIONE ACCELERATORE	23117570
12 46 313	V35-V35TT-V50	TRASMISSIONE ACCELERATORE	19117550
12 46 315	V35 IMOLA II	TRASMISSIONE ACCELERATORE	27117520
12 46 333	V35 CUSTOM	TRASMISSIONE ACCELERATORE	19117545
12 46 464	V50 CUSTOM	TRASMISSIONE ACCELERATORE	19117595
12 46 463	V65-TT-SP-V50	TRASMISSIONE ACCELERATORE	19117580
12 46 408	850 LE MANS III	TRASMISSIONE ACCELERATORE	28117550
12 46 380	1000 SP - 850 T	TRASMISSIONE ACCELERATORE	17117561
12 46 435	1000 SP II-850	TRASMISSIONE ACCELERATORE	28117500
12 46 465	1000 CALIFORNIA	TRASMISSIONE ACCELERATORE	29117500
12 46 466	1000 LE MANS	TRASMISSIONE ACCELERATORE	28117560
MOTO MORINI			
12 47 447	350 SPORT	COPPIA TRASMISSIONE GAS	N.D.
PEUGEOT			
12 54 354	50 METROPOLIS SC	TRASMISSIONE ACCELERATORE	705222
12 54 428	50-125 GEO SV	TRASMISSIONE ACCELERATORE	724327
12 54 429	50 ST-RAPIDO	TRASMISSIONE ACCELERATORE	712096
PIAGGIO			
12 56 341	VESPA 50 ET2	TR ACCELERATORE ALTO	581883
12 56 369	ZIP 50	TR ACCELERATORE ALTO	269059
	ZIP 50 Disco	TR ACCELERATORE ALTO	268435
12 56 357	TYPHOON 50 NRG-STORM (GILERA)	TR ACCELERATORE ALTO	270995
	ZIP 50 FAST RAIDER - SP	TR ACCELERATORE ALTO	268435
	LIBERTY 50	TR ACCELERATORE ALTO	268435
	SFERA 50	TR ACCELERATORE ALTO	268435
	QUARTZ 50	TR ACCELERATORE ALTO	268435
12 56 374	SKIPPER 125-150	TR ACCELERATORE ALTO	271463
12 56 374	FREE 50	TR ACCELERATORE ALTO	268598
12 56 379	SFERA 50	TR ACCELERATORE ALTO	267981
12 56 075	VESPA 125 ETS	TRASMISSIONE ACCELERATORE	225652
12 56 342	VESPA 50 ET2	SERIE TRASMISSIONI GAS	581883+563227+562408
12 56 426	ZIP 50 Tamburo	SERIE TRASMISSIONI GAS	269059+268811+268812
12 56 387	ZIP 50 Disco	SERIE TRASMISSIONI GAS	268435+268402+268812
12 56 389	ZIP 50 FAST RAIDER	SERIE TRASMISSIONI GAS	268435+268402+271829
12 56 381	FREE 50	SERIE TRASMISSIONI GAS	268598+269064+268597
12 56 384	SFERA 50	SERIE TRASMISSIONI GAS	267981+267017+267018
12 56 377	SFERA 50 RST	SERIE TRASMISSIONI GAS	268435+268402+560448
12 56 383	QUARTZ 50	SERIE TRASMISSIONI GAS	268435+268402+268403
12 56 331	LIBERTY 50	SERIE TRASMISSIONI GAS	268435+561154+957297
12 56 391	SKIPPER 125-150	SERIE TRASMISSIONI GAS	268435+268402+271624
12 56 382	HEXAGON 125-150	SERIE TRASMISSIONI GAS	271463+271481
GILERA			
12 56 002	EXTREME 50 MC3	TR ACCELERATORE ALTO	581539
12 56 396	RUNNER 50-125-180 2T All Model	TR ACCELERATORE ALTO	563878-562583
12 56 386	TYPHOON 50 NRG	SERIE TRASMISSIONI GAS	270995+272289+272290
12 56 003	EXTREME 50 MC3 ->2001	SERIE TRASMISSIONI GAS	581539+583808+583334
12 56 004	EXTREME 50 MC3 2002->	SERIE TRASMISSIONI GAS	581539+560448+582256
12 56 420	RUNNER50	SERIE TRASMISSIONI GAS	563878+581173+268403
12 56 431	RUNNER 125-180 2T	SERIE TRASMISSIONI GAS	563878+563213+582449
YAMAHA			
12 41 479	50 BOOSTER-R-NG	TR ACCELERATORE ALTO	3VLF631100
12 41 350	50 CR Z-TARGET	TR ACCELERATORE ALTO	3GFF631100
12 41 455	50 OVETTO-NEOS	TR ACCELERATORE ALTO	5ADF631100
12 41 309	50 BOOSTER-R-NG	TRASMISSIONE ACCELERATORE	3VLF631200
12 41 327	50 EVOLIS-FIZZ	TRASMISSIONE ACCELERATORE	4CUF631200
12 41 330	50 OVETTO-NEOS	TRASMISSIONE ACCELERATORE	5ADF631200
12 41 348	50 CT-SORRISO	TRASMISSIONE ACCELERATORE	1NTF631100

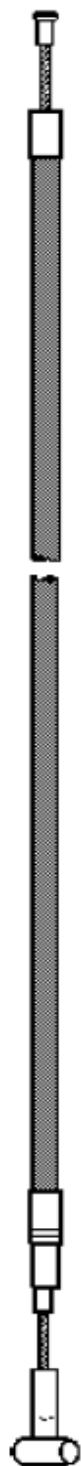

ARTICOLO	APPLICAZIONE	DESCRIZIONE	SIMILE
APRILIA			
14 01 019	50 RS 1999->	TRASMISSIONE FRIZIONE	8214178
14 01 323	50 RED ROSE	TRASMISSIONE FRIZIONE	8214040
14 01 494	50 AF1 87-88	TRASMISSIONE FRIZIONE	8214031
14 00 358	50 ET 84-87-TUAREG-CAGIVA 125 SST	TRASMISSIONE FRIZIONE	8214025
14 01 018	125 EXTREMA 1997->	TRASMISSIONE FRIZIONE	8114467
14 01 496	125 AF1 All Mod	TRASMISSIONE FRIZIONE	8114117
14 01 484	125 RALLY ->1987-ETX-TUAREG-PEGASO	TRASMISSIONE FRIZIONE	8114107
14 01 497	350-600 WIND 88	TRASMISSIONE FRIZIONE	8114103
14 01 439	350 ETX	TRASMISSIONE FRIZIONE	8114069
CAGIVA			
14 09 017	125 MITO 1993->	TRASMISSIONE FRIZIONE	800077777
14 09 336	125 MITO ->1992	TRASMISSIONE FRIZIONE	66166
14 09 490	125 FRECCIA C9	TRASMISSIONE FRIZIONE	53699
14 09 321	125 CRUISER TAMANACO	TRASMISSIONE FRIZIONE	54941
14 09 398	125 SXT 82 ALETTA ROSSA	TRASMISSIONE FRIZIONE	34878
	125 ELEFANT II-200 ELEFANT	TRASMISSIONE FRIZIONE	39233
	125 ELEFANTRE	TRASMISSIONE FRIZIONE	49821
14 09 421	250 SXT-250 ALABLU	TRASMISSIONE FRIZIONE	37844
	125 SST-125 ELETTRA	TRASMISSIONE FRIZIONE	41214
14 09 457	250-350 SST	TRASMISSIONE FRIZIONE	35542
	350 ALAROSSA	TRASMISSIONE FRIZIONE	39169
FANTIC MOTOR			
14 16 303	TRIAL 240-243-245-301-303-305	TRASMISSIONE FRIZIONE	230342
GILERA			
14 20 364	125 KK-KZ	TRASMISSIONE FRIZIONE	N.D.
14 20 404	125 RX-ARIZONA	TRASMISSIONE FRIZIONE	N.D.
HONDA			
14 25 359	125 NS-R 1988	TRASMISSIONE FRIZIONE	22870KR1860
14 25 472	125 NS - 350 FOUR	TRASMISSIONE FRIZIONE	22870KR1760
14 25 474	125 MTX	TRASMISSIONE FRIZIONE	22870KS3900
14 25 005	600 HORNET	TRASMISSIONE FRIZIONE	22870MBZG00
14 25 476	600 XL R-M	TRASMISSIONE FRIZIONE	22870MG2000
14 25 375	400 N	TRASMISSIONE FRIZIONE	22870443610
14 25 318	400 FOUR	TRASMISSIONE FRIZIONE	22870377000
14 25 319	500 FOUR	TRASMISSIONE FRIZIONE	22870323020
14 25 395	500 XL	TRASMISSIONE FRIZIONE	22870MC4000
14 25 320	750 FOUR	TRASMISSIONE FRIZIONE	22870341611
KAWASAKI			
14 27 409	550-500 GP Z	TRASMISSIONE FRIZIONE	540111259
14 27 300	600 KLR	TRASMISSIONE FRIZIONE	540111214
14 27 322	900 - 1000	TRASMISSIONE FRIZIONE	540111003
MOTO GUZZI			
14 46 485	FLORIDA 35C-65C	TRASMISSIONE FRIZIONE	23093070
14 46 406	V35 I II IIIs - IMOLA I IIs	TRASMISSIONE FRIZIONE	19093052
	V50 I II III -MONZA 500	TRASMISSIONE FRIZIONE	19093052
	V65 SP LARIO	TRASMISSIONE FRIZIONE	19093052
14 46 462	V35-50-65 CUSTOM-TT	TRASMISSIONE FRIZIONE	23093080
14 46 469	1000 CALIFORNIA	TRASMISSIONE FRIZIONE	29093000
14 46 365	1000 SP IIs	TRASMISSIONE FRIZIONE	28093010
14 46 434	1000 LE MANS II	TRASMISSIONE FRIZIONE	14093051
14 46 316	1000 LE MANS I	TRASMISSIONE FRIZIONE	14093050
14 46 352	1000 LE MANS	TRASMISSIONE FRIZIONE	28093060
MOTO MORINI			
14 47 324	125 H	TRASMISSIONE FRIZIONE	360136
14 47 325	125-150-350 SPORT	TRASMISSIONE FRIZIONE	360120
14 47 326	350 EXALIBUR	TRASMISSIONE FRIZIONE	360180
14 47 327	350-500 TURISMO	TRASMISSIONE FRIZIONE	360143
14 47 328	501 EXALIBUR	TRASMISSIONE FRIZIONE	360181
14 47 491	501 KANGURO	TRASMISSIONE FRIZIONE	360168
SUZUKI			
14 61 492	600 DR	TRASMISSIONE FRIZIONE	5820015A00
YAMAHA			
14 64 407	550/600-TENERE	TRASMISSIONE FRIZIONE	34L2633500



VALVOLE LAMELLARI

ARTICOLO	APPLICAZIONE	DESCRIZIONE
	APRILIA 50cc AF1-RX	VALVOLA LAMELLARE VETRONITE
	CAGIVA 125cc	VALVOLA LAMELLARE VETRONITE
	GILERA 125cc	VALVOLA LAMELLARE VETRONITE



LAMELLE PER VALVOLE LAMELLARI

ARTICOLO	APPLICAZIONE	DESCRIZIONE	MISURE		
			h	L	Fori
	APRILIA 50 FBM AM3-4-5	COPPIA LAMELLE VETRONITE	39,6	41,0	2 - 19,0
	CAGIVA 125cc	COPPIA LAMELLE CARBONIO	47,1	61,0	3 - 20,0
	15 09 803 125cc	COPPIA LAMELLE VETRONITE			
	15 09 807 125cc	SERIE LAMELLE VETRONITE			
15 09 814 50 CITY	LAMELLA VETRONITE	37,0	41,0	2 - 20,0	
	GILERA 125cc	COPPIA LAMELLE CARBONIO	43,0	60,0	3 - 20,0
	15 20 805 125cc	COPPIA LAMELLE VETRONITE			
	HONDA 125cc	COPPIA LAMELLE CARBONIO	31,0	38,0	2 - 10,0
	15 25 809 125cc	COPPIA LAMELLE VETRONITE			
	15 25 815 50 BALI-DIO	LAMELLA VETRONITE	30,0	37,0	2 - 20,0
	15 25 816 50 WALLAROO	LAMELLA VETRONITE			
	K T M 125cc	COPPIA LAMELLE VETRONITE	32,0	32,0	2 - 15,0
	15 29 806 125cc	SERIE LAMELLE VETRONITE			
	MALAGUTI 50 F 10 -TEMPO	COPPIA LAMELLE VETRONITE	39,0	32,0	2 - 20,0
	15 38 813				
15 54 817	50 GEO-METROPOLIS	LAMELLA VETRONITE	42,0	38,0	2 - 19,0
15 56 818	50 ZIP-SFERA	COPPIA LAMELLE VETRONITE			
15 41 812	BOOSTER-AMICO-CRZ	LAMELLA VETRONITE			

MISURE		
h	L	Fori
39,6	41,0	2 - 19,0
47,1	61,0	3 - 20,0
37,0	41,0	2 - 20,0
43,0	60,0	3 - 20,0
31,0	38,0	2 - 10,0
30,0	37,0	2 - 20,0
32,0	32,0	2 - 15,0
39,0	32,0	2 - 20,0
42,0	38,0	2 - 19,0



FASCETTE IN NYLON

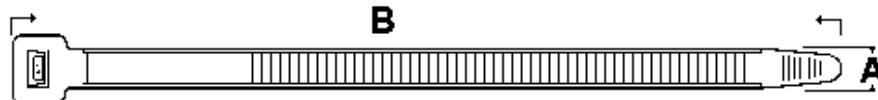

ARTICOLO	DESCRIZIONE
20 00 060	AUTOBLOCCANTI IN NYLON NERE
20 00 061	AUTOBLOCCANTI IN NYLON NERE
20 00 062	AUTOBLOCCANTI IN NYLON NERE
20 00 063	AUTOBLOCCANTI IN NYLON NERE

A	B	Q.TA'
3,6 mm	150 mm	100
4,8 mm	190 mm	100
4,8 mm	280 mm	100
8,0 mm	450 mm	50



FILTRI ARIA IN BAGNO D'OLIO



ARTICOLO	APPLICAZIONE	DESCRIZIONE	SIMILE
APRILIA			
16 01 900	50 AMICO 90->95	FILTRO ARIA IN BAGNO D'OLIO	8201378
16 01 906	50 RALLY-SR-WWW-SONIC-STEALT	FILTRO ARIA IN BAGNO D'OLIO	8201683
16 01 917	50 SCARABEO 94->02	FILTRO ARIA IN BAGNO D'OLIO	8201583
16 01 919	50 SR EAQUIRE	FILTRO ARIA IN BAGNO D'OLIO	
16 01 923	125-150 LEO 97->99 AMICO 95->	FILTRO ARIA IN BAGNO D'OLIO	8102582
16 01 959	125/150/200/2504T SCARABEO	FILTRO ARIA IN BAGNO D'OLIO	8102832
16 01 963	125/200 ATLANTIC 03->	FILTRO ARIA IN BAGNO D'OLIO	8580172
16 01 964	150/250/300 LEONARDO 99-06	FILTRO ARIA IN BAGNO D'OLIO	8102860
16 01 965	100 2T SCARABEO	FILTRO ARIA IN BAGNO D'OLIO	8104041
16 01 966	100 4T SCARABEO	FILTRO ARIA IN BAGNO D'OLIO	8202249
BETA			
16 05 925	50 TEMPO	FILTRO ARIA IN BAGNO D'OLIO	
CAGIVA			
16 09 901	50 CITY	FILTRO ARIA IN BAGNO D'OLIO	17205G03000
HONDA			
16 25 903	50 HSC SC 01	FILTRO ARIA IN BAGNO D'OLIO	17205GAH000
16 25 904	50 BALI	FILTRO ARIA IN BAGNO D'OLIO	17205GUA700
16 25 920	50 SH	FILTRO ARIA IN BAGNO D'OLIO	
16 25 960	125/150 2/4T PANTHEON	FILTRO ARIA IN BAGNO D'OLIO	17205KEY900
MALAGUTI			
16 38 922	50 F 15 FIREFOX	FILTRO ARIA IN BAGNO D'OLIO	066.045.00
PEUGEOT			
16 54 910	50 SC METROPOLIS	FILTRO ARIA IN BAGNO D'OLIO	705260
16 54 911	50 GEO SV	FILTRO ARIA IN BAGNO D'OLIO	724064
16 54 921	50 BUXY-ZENIT	FILTRO ARIA IN BAGNO D'OLIO	
GILERA - PIAGGIO			
16 56 902	50 TYPHOON-NRG-STORM-NTT	FILTRO ARIA IN BAGNO D'OLIO	433437
16 56 912	50 SFERA	FILTRO ARIA IN BAGNO D'OLIO	257369
16 56 914	50 ZIP FAST RAIDER	FILTRO ARIA IN BAGNO D'OLIO	834741
16 56 916	50 FREE	FILTRO ARIA IN BAGNO D'OLIO	431587
16 56 924	50 LIBERTY	FILTRO ARIA IN BAGNO D'OLIO	482738
16 56 929	50 SP-ZIP RST 97	FILTRO ARIA IN BAGNO D'OLIO	478536
16 56 951	50 RUNNER-STALKER	FILTRO ARIA IN BAGNO D'OLIO	479748
16 56 961	50 MC3-DNA-ICE-ZIP 2000->	FILTRO ARIA IN BAGNO D'OLIO	487719
16 56 927	50/125 VESPA ET2-ET4	FILTRO ARIA IN BAGNO D'OLIO	436478
16 56 953	50/125/150 4T LIBERTY	FILTRO ARIA IN BAGNO D'OLIO	487287
16 56 954	50/125/150 4T--LEADER-SKIPPER	FILTRO ARIA IN BAGNO D'OLIO	487401
16 56 956	125 4T ZIP	FILTRO ARIA IN BAGNO D'OLIO	827694
16 56 957	125 DNA-180 RUNNER-VX-X9	FILTRO ARIA IN BAGNO D'OLIO	827936
16 56 950	125 QUARTZ-SKIPPER-TYPHOON	FILTRO ARIA IN BAGNO D'OLIO	478240
16 56 962	125/200 X8-GRANTURISMO	FILTRO ARIA IN BAGNO D'OLIO	831997
16 56 952	150 2T RUNNER FX-SKIPPER	FILTRO ARIA IN BAGNO D'OLIO	480084
16 56 928	250 HEXAGON GT	FILTRO ARIA IN BAGNO D'OLIO	495375-434363
16 56 958	BEVERLY-X9-EVOLUTION-VXR	FILTRO ARIA IN BAGNO D'OLIO	829258
SUZUKI			
16 61 918	50 ADRESS	FILTRO ARIA IN BAGNO D'OLIO	
16 61 932	250-400 BURGMAN	FILTRO ARIA IN BAGNO D'OLIO	13780-14F01
YAMAHA			
16 41 905	50 CR Z-TARGET	FILTRO ARIA IN BAGNO D'OLIO	3GFE445100
16 41 907	BOOSTER 50 - BWS 50	FILTRO ARIA IN BAGNO D'OLIO	3VLE445100
16 41 908	50 CT-SORRISO	FILTRO ARIA IN BAGNO D'OLIO	1NTE445100
16 41 909	YAMAHA-BENELLI-BETA	FILTRO ARIA IN BAGNO D'OLIO	066.045.00
16 41 926	250 MAJESTY-SKYLAINER-MADISON	FILTRO ARIA IN BAGNO D'OLIO	84HC1445100-6608100
16 41 930	50 FLIPPER	FILTRO ARIA IN BAGNO D'OLIO	4VPE44510000

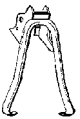
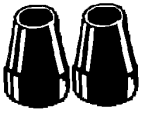

CAVALLETTI

ARTICOLO	APPLICAZIONE	DESCRIZIONE	SIMILE
	17 01 151 VESPA 50-ET3 17 01 152 VESPA 125-150 GL-GT 17 01 153 VESPA 50-125 PK 17 01 155 VESPA 125-150 PX-200 PE	CAVALLETTO CENTRALE CAVALLETTO CENTRALE CAVALLETTO CENTRALE CAVALLETTO CENTRALE	1353846 54140 2162476 176160
	17 01 150 CIAO R 17 01 156 CIAO PX 17 01 157 BOXER 17 01 158 SI-BOSS 17 01 159 BRAVO IIs	CAVALLETTO CENTRALE CAVALLETTO CENTRALE CAVALLETTO CENTRALE CAVALLETTO CENTRALE CAVALLETTO CENTRALE	10463101 2553001 142937 1858693 214495T
	17 01 154 CIAO R 17 01 162 CIAO-SI 17 01 174 BRAVO	PERNO CAVALETTO PERNO CAVALETTO C/SIGER PERNO CAVALETTO C/SIGER	
	17 01 160 PX - PE- P150S - PX Disco 17 01 172 VESPA ET3 17 01 173 VESPA PX	COPPIA PIASTRE CAVALLETTO COPPIA PIEDINI CAVALETTO COPPIA PIEDINI CAVALETTO	176168 - 258733



COLLETTORI

ARTICOLO	APPLICAZIONE	DESCRIZIONE	SIMILE
	17 02 300 VESPA 90	COLLETTORE SCARICO	247033
	17 02 301 VESPA 50 SPECIAL 17 02 302 VESPA 50 SPECIAL 90 17 02 303 VESPA 50-125 PRIMAVERA 17 02 308 APE 50 TM 17 02 309 VESPA 125 ET3 17 02 310 VESPA 125 PK 17 02 311 APE 250 TM	COLL. ASPIRAZIONE D 14 COLL. ASPIRAZIONE D 16 COLL. ASPIRAZIONE D 19 COLLETTORE ASPIRAZIONE COLLETTORE ASPIRAZIONE COLLETTORE ASPIRAZIONE COLLETTORE ASPIRAZIONE	4161114 0785425 112869 116446 134125 198178 127183
	17 02 314 50cc AM 345/6	COLL. ASPIRAZIONE D 19	
	17 02 304 VESPA 50 SPECIAL 17 02 305 VESPA PRIMAVERA ET3 17 02 312 VESPA 50 PK 17 02 313 VESPA 125 PK	CONO ASPIRAZIONE CONO ASPIRAZIONE CONO ASPIRAZIONE CONO ASPIRAZIONE	1100034 112517 196778



LEVE FRENO FRIZIONE

ARTICOLO	APPLICAZIONE	DESCRIZIONE	SIMILE
	17 03 101 VESPA 125-150 GL 17 03 102 VESPA 125-150 17 03 103 VESPA 50-ET3 17 03 107 VESPA 125-150-200 PX 17 03 106 VESPA T5	LEVA FRENO FRIZIONE LEVA FRENO FRIZIONE LEVA FRENO FRIZIONE LEVA FRENO FRIZIONE LEVA FRENO FRIZIONE	51097 33882 1652194 2425314 219336
	17 03 104 VESPA ET2 ET4 LIBERTY 17 03 105 VESPA ET2 ET4 LIBERTY	LEVA FRENO SINISTRA LEVA FRENO DESTRA	560579 494473
	17 03 111 CIAO-SI 17 03 112 VESPA 50-125-150-200	COPPIA LEVE NERE COPPIA LEVE SPORT	



PEDIVELLE AVVIAMENTO

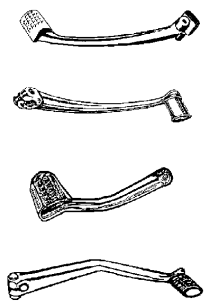

ARTICOLO	APPLICAZIONE	DESCRIZIONE
17 04 126	VESPA 50 125 PRIMAVERA ET3	PEDIVELLA AVVIAMENTO
17 04 120	VESPA 50-125 VESPA-PK	PEDIVELLA AVVIAMENTO
17 04 121	VESPA 125-150	PEDIVELLA AVVIAMENTO
17 04 122	VESPA 125-150 GL-GT	PEDIVELLA AVVIAMENTO
17 04 125	VESPA 125-150-200 PX	PEDIVELLA AVVIAMENTO
17 04 123	VESPA ET4	PEDIVELLA AVVIAMENTO
17 04 130	VESPA PX/PE	KIT GOMMA PEDIVELLA M/M

SIMILE
79077
234351
94337
150003
1743125
479133



PERNI MOLLEGGIO

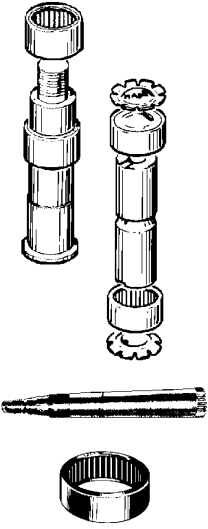

ARTICOLO	APPLICAZIONE	DESCRIZIONE
17 05 000	VESPA 50-50PK-ET3	PERNO MOLLEGGIO COMPLETO
17 05 002	VESPA 125-150 GL	PERNO MOLLEGGIO COMPLETO
17 05 006	VESPA 125-150-200 PX	PERNO MOLLEGGIO COMPLETO
17 05 008	VESPA 125-150-200 PX	PERNO MOLLEGGIO COMPLETO
17 05 004	APE MP (18x74mm)	PERNO MOLLEGGIO COMPLETO
17 05 005	APE CAR (18x84mm)	PERNO MOLLEGGIO COMPLETO
17 05 005M	APE CAR (18x84mm)	MOLLEGGIO COMPLETO C/FORO
17 05 009	APE TM 703 (18x91mm)	PERNO MOLLEGGIO COMPLETO
17 05 009M	APE TM 703 (18x91mm)	MOLLEGGIO COMPLETO C/FORO
17 05 010	APE MAX-DIESEL	PERNO MOLLEGGIO COMPLETO
17 05 001	VESPA 125/150 PX	ASSE RUOTA ANTERIORE
17 05 003	APE MAX TM DIESEL	ASSE RUOTA ANTERIORE
17 05 011	APE Diametro 30	ASSE RUOTA ANTERIORE
17 05 007	VESPA 50-50PK-ET3	BOCCOLA MOLLEGGIO

SIMILE
70181+90457
78731+152387+91621
174098+174099
177451+137146
125126
107718
107718
154604
154604
NADELLA



CROCIERE PRESELETTORI CAMBIO

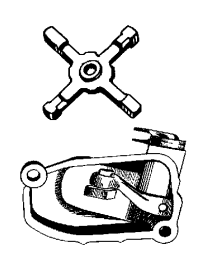

ARTICOLO	APPLICAZIONE	DESCRIZIONE
17 06 130	VESPA PX125-150	CROCIERA CAMBIO
17 06 131	VESPA T5-COSA-ARCO	CROCIERA CAMBIO
17 06 136	VESPA PX	PRESELETTORE CAMBIO
17 06 137	VESPA COSA-ARCOBALENO	PRESELETTORE CAMBIO
17 06 133	APE C3-C4	PRESELETTORE CAMBIO
17 06 134	APE AD1	PRESELETTORE CAMBIO
17 06 135	APE MP-CAR	PRESELETTORE CAMBIO

SIMILE
1309396
223225
1388806
199803
93310
79288
113310



TAMBURI FRENO ANTERIORE

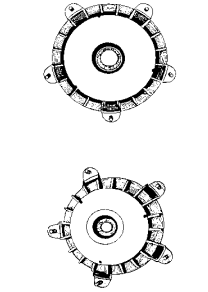

ARTICOLO	APPLICAZIONE	DESCRIZIONE
17 07 858	VESPA 125 ET3	TAMBURO FRENO ANTERIORE
17 07 860	VESPA 50-125 PX/XL 50 FL	TAMBURO FRENO ANTERIORE
17 07 862	VESPA 50-125 PK	TAMBURO FRENO ANTERIORE
17 07 864	VESPA 125-150-200 PX (D30)	TAMBURO FRENO ANTERIORE
17 07 863	VESPA ARCOBALENO	TAMBURO FRENO ANTERIORE

SIMILE
159374
215994
216001
174032
177444



TAMBURI FRENO POSTERIORE

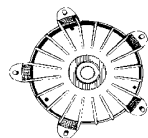

ARTICOLO

APPLICAZIONE

DESCRIZIONE

SIMILE

17 07 854

VESPA 125 ET3

TAMBURO FRENO POSTERIORE

100484

17 07 856

VESPA 125-150 PX-GL-ARCO

TAMBURO FRENO POSTERIORE

194433

17 07 857

VESPA 125-150-200 PX (D27)

TAMBURO FRENO POSTERIORE

0784804

17 07 865

VESPA 50-125 PK

TAMBURO FRENO POSTERIORE

2159934

17 07 866

COSA

TAMBURO FRENO POSTERIORE

2291144

17 07 859

VESPA 125-150 PX DISCO 98 -->

TAMBURO FRENO POSTERIORE

2427724

17 07 867

APE 50 TM

TAMBURO FRENO POSTERIORE

116441

17 07 870

125-150-175 LI

TAMBURO FRENO POSTERIORE

19545140

17 07 871

50 JUNIOR

TAMBURO FRENO POSTERIORE

20157020

17 07 873

175 FLI

TAMBURO FRENO POSTERIORE

17 10 880

LAMBRETTA

CONO PER TAMBURO

17 08 200

VESPA 50/125/PX

CERCHIO RUOTA 3.50x10

17 10 840

125-150PX - 200PE

CERCHIO RUOTA CROMATA



TUBI COMANDO

ARTICOLO

APPLICAZIONE

DESCRIZIONE

SIMILE

17 10 001

VESPA 50-90cc D.75

TUBO CAMBIO

138011

17 10 830

VESPA PRIMAVERA ET3

TUBO CAMBIO

1378406

17 10 831

VESPA 50 SPECIAL

TUBO CAMBIO

1382235

17 10 832

VESPA 125-150

TUBO CAMBIO

2232255

17 10 833

VESPA PRIMAVERA ET3

TUBO GAS

175385

17 10 834

VESPA 125150-200 PX

TUBO GAS

139778

17 10 835

VESPA 50 SPECIAL

TUBO GAS

137939



TENDICATENA

ARTICOLO

APPLICAZIONE

DESCRIZIONE

SIMILE

17 10 814

CIAO

TENDICATENA

17 10 815

BOXER

TENDICATENA

17 10 816

SI

TENDICATENA



RICAMBI VARI

ARTICOLO

APPLICAZIONE

DESCRIZIONE

SIMILE

17 10 820

APE MP-CAR

RACCORDO CARBURATORE

17 10 821

APE MP-CAR

SUPPORTO MOTORE

17 10 836

APE MP-CAR

GIUNTO ELASTICO

17 10 837

POKER-MAX

GIUNTO ELASTICO

2283020001



KIT CILINDRO CAGIVA COCIS - PRIMA

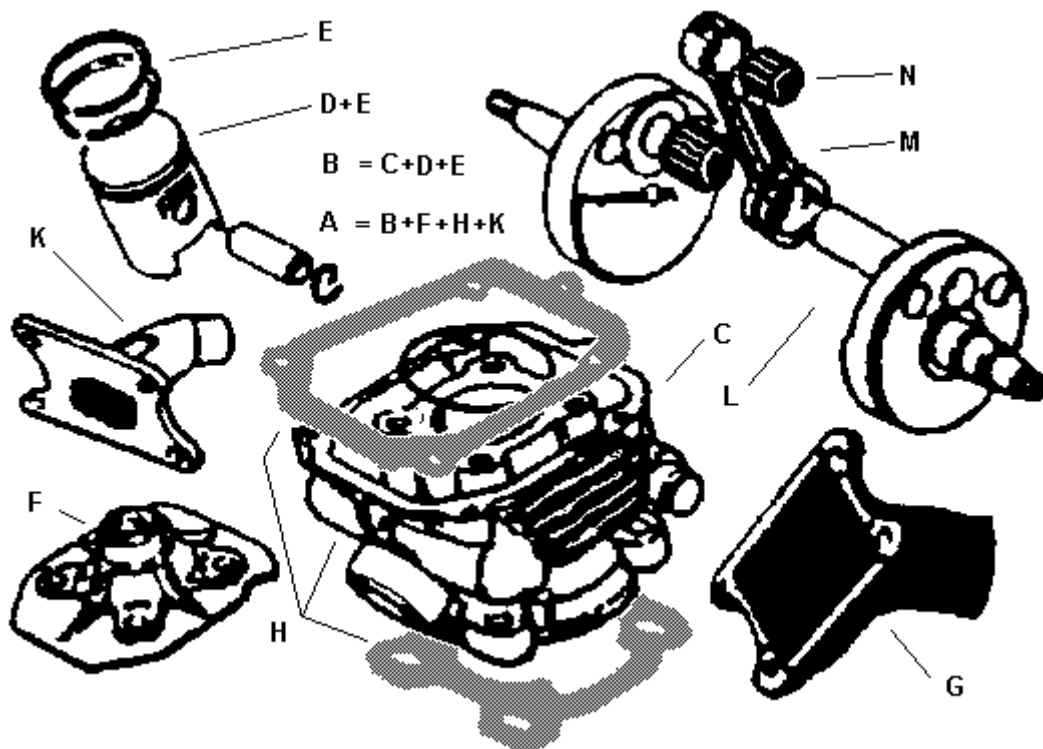

A	18 00 010	KIT CILINDRO D 46.5
B	18 00 002	CILINDRO COMPLETO D 46.5
C	18 00 000	CILINDRO NUDO D 46.5
D	18 00 001	PISTONE COMPLETO D 46.5
E	18 00 003	SERIE FASCE ELASTICHE D46.5
F	18 00 004	TESTATA
G	18 00 005	COLLETTORE GOMMA D 20
H	18 00 006	SERIE GUARNIZIONI TESTA
K	18 00 007	COLLETTORE ALLUMINIO D 19
L	18 00 011	ALBERO MOTORE CORSA 44
M	18 00 009	BIELLA COMPLETA ARGENTO
N	18 00 008	GABBIA A RULLI 12x17x15

SIMILE
60487
60489
60493
60902
67139
62877
53280
53291
53290

PER MODIFICA SU: PRIMA - W4 - SUPER CITY = SOSTITUZIONE ALBERO MOTORE



KIT CILINDRO FANTIC CABALLERO

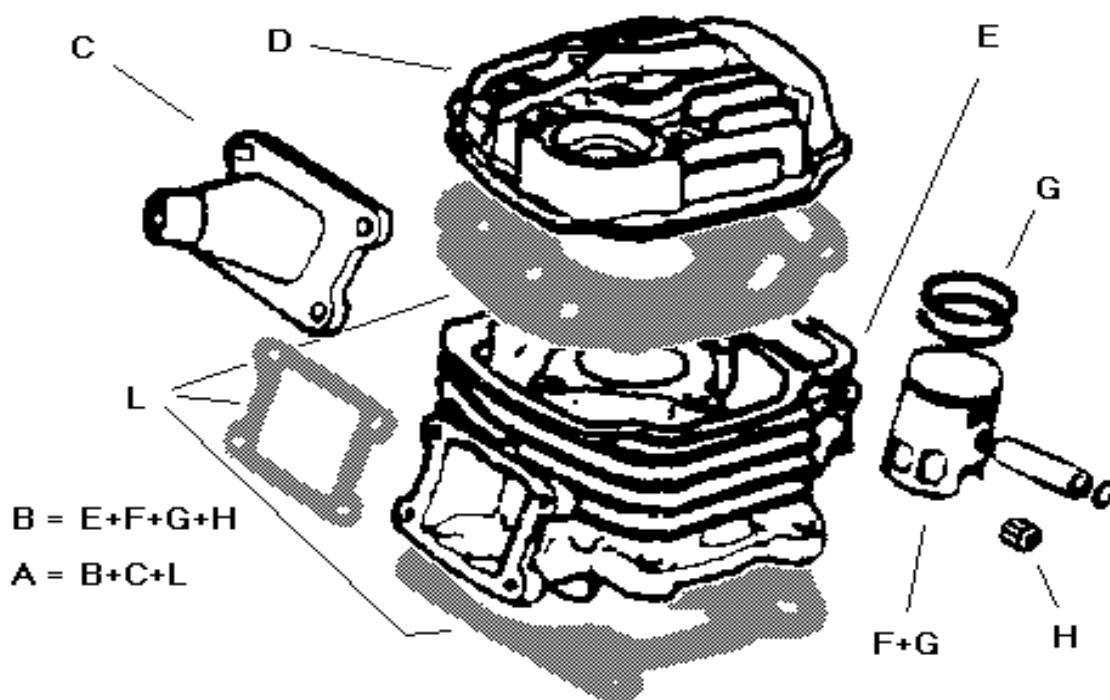

A	19 00 010	KIT CILINDRO D 47.5
B	19 00 002	CILINDRO COMPLETO D 47.5
C	19 00 005	COLLETTORE ALLUMINIO D 19
D	19 00 004	TESTATA
E	19 00 000	CILINDRO NUDO D.47.5
F	19 00 001	PISTONE COMPLETO D 47.5
G	19 00 003	SERIE FASCE D.47.5
H	19 00 008	GABBIA A RULLI 13x17x17,7
L	19 00 006	SERIE GUARNIZIONI TESTA

SIMILE
41250005020
41348005050
36947005800
41347005000
41347005200
369470054/55

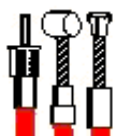
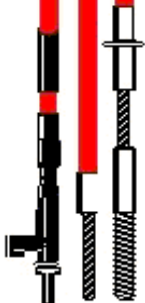

MOTORICAMBIO SAS

Via Quintino Sella 19 - 20094 Corsico (MI)

Tel 02 4586 3846 - Fax 02 4586 4399

E-mail: motoricambio@virgilio.it - www.motoricambio.it